



Ti SALES

36 Hudson Rd
Sudbury MA 01776



800-225-4616
www.tisales.com



THE FORD METER BOX COMPANY, INC.
CERTIFIED TO ISO 9001:2015
10004466

Ford[®] Coppersetters, Section F Linesetters and Resetters

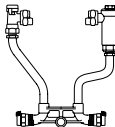
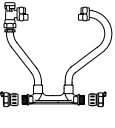
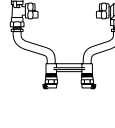
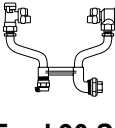
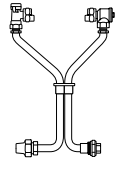
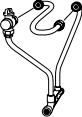
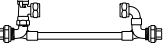
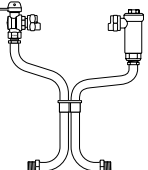
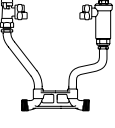
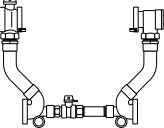
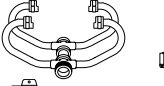
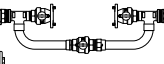
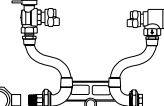

Contents

	Page
Information	
Secura-Lok™ Locking Valves for Coppersetters	3
Ford Coppersetter Numbering System	4
Features of Ford Coppersetters, Linesetters and Resetters	5
Setter Service Line Connections	6
Gaskets	6
 Ford 70 Series Coppersetter	
Options Available on 70 Series Coppersetters	7
Ford 70 Series Coppersetters	8 - 12
 Ford 270 Series Coppersetter	
Options Available on 270 Series Coppersetters	13
Ford 270 Series Coppersetters	14, 15
Pack Joint Assemblies for 270 Series Coppersetters	15
 Ford 80 Series Coppersetter	
Options Available on 80 Series Coppersetters	16
Ford 80 Series Coppersetters	17, 18
 Ford 70-80 Series Angle Coppersetter	
Options Available on 70-80-Series Angle Coppersetters	19
Ford 70-80 Series Angle Coppersetters	20, 21
 Ford 90 Series Coppersetter	
Options Available on 90 Series Coppersetters	22
Ford 90 Series Coppersetters	23 - 25
 Ford Tandem Coppersetters	26
 Ford Linesetters	27 - 31
Ford Coppersetters for 1-1/2" and 2" Flanged Meters	
Specifications	32
Ford Coppersetters for 1-1/2" and 2" Flanged Meters	33 - 40
High By-Pass Option	41
1-1/2" and 2" Coppersetter Parts	42
Optional Couplings	42
 Ford 30 Series Flexible Resetter	43, 44
 Ford 40 Series Resetter	
Options Available on the Ford 40 Series Resetter	45
Change-Over Resetters	46
Resetter Dimensions	47
Ford 40 Series Resetters	48
 Ford Resetters for 1-1/2" and 2" Flanged Meters	
Specifications	49
Ford Resetters for 1-1/2" and 2" Flanged Meters	50 - 53
 Ford Type A and Type B Tandem Resetters	53
 Ford No-Rise Setters	54
 Metering Manifolds	55
Warranty	56

Refer to the Ford Meter Box website (www.fordmeterbox.com) for additional and most recent instructions and product information.

Due to design improvements, product images in the catalog do not always reflect the most current design detail.

Ford, Ford Meter Box and Uni-Flange are trademarks of The Ford Meter Box Company, Inc. registered in the U.S.

Locking Valves for Copper setters

Secura-Lok™ Valves for Setters

(Patent Number 10,794,514)

Whether you choose to lock a setter open, closed or operational, secure your decision with Ford Secura-Lok™ locking valves. Available on the inlet, outlet or by-pass valve.

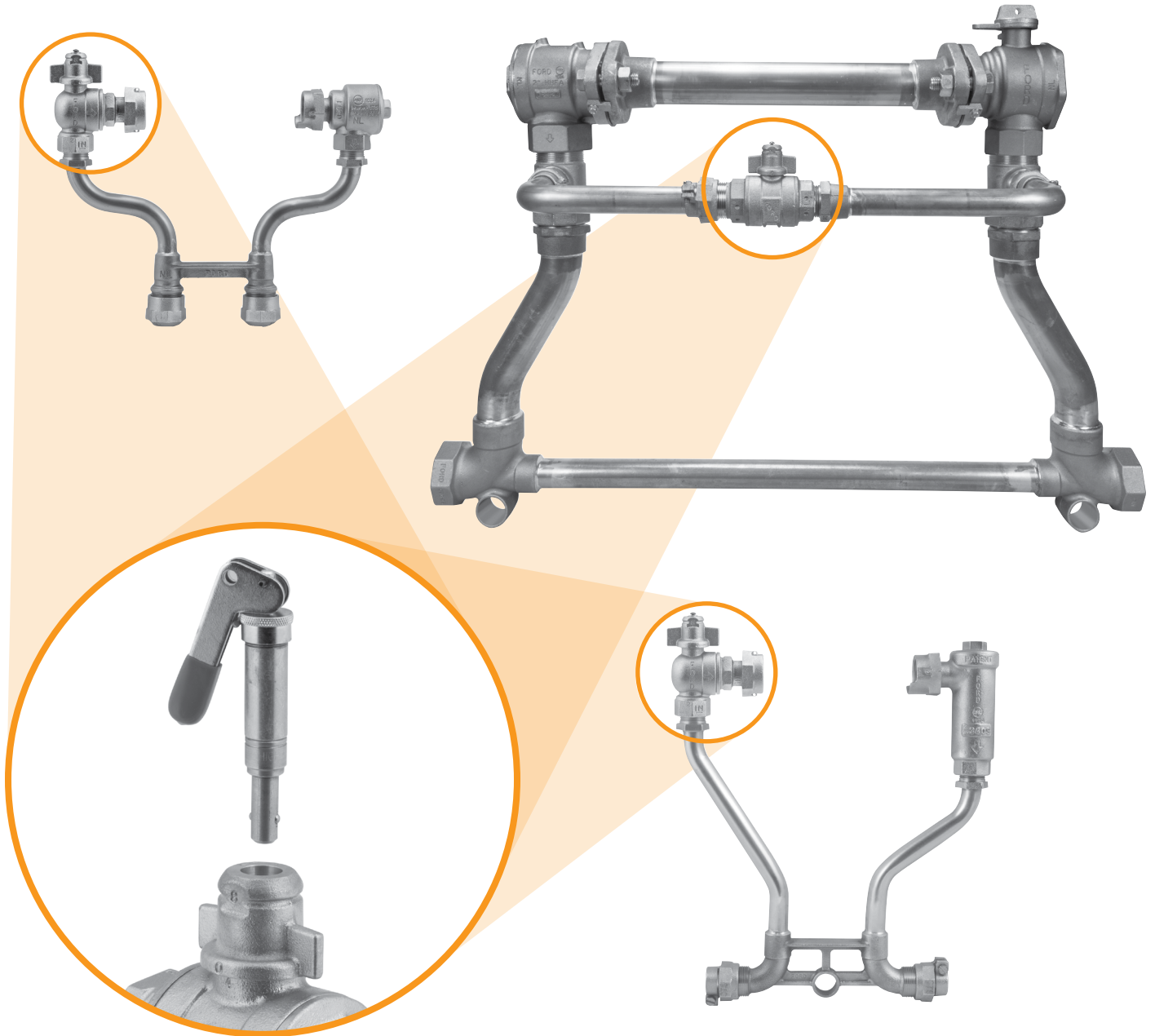

Secura-Lok Options

PART NUMBER CODE	DESCRIPTION	EXAMPLE
SB1	Barrel-style Secura-Lok on inlet valve only	VB74-15SB1-44-66-NL
SB2	Barrel-style Secura-Lok on inlet and outlet valves	VBB94-18SB2-44-33-NL
SB3	Barrel-style Secura-Lok on inlet, outlet and by-pass valves	VBB77-12BHC-11-77-SB3-NL
SB4	Barrel-style Secura-Lok on by-pass valve only	VBHH76-18HBHC-11-66-SB4-NL

To order Secura-Lok™ valves on Ford Copper setters, insert the "SB" code into the part number.

Note: Due to the wide variety of copper setter configurations, please contact customer service for a specific part number.

***Type of meter inlet valve & outlet valve**

- T = "T" in front of the catalog number indicates a tandem style setter
 - V = inlet key valve & no outlet valve
 - VV = inlet key valve & outlet key valve
 - VVG = inlet key valve & compression outlet valve
 - VH = inlet key valve & outlet single check valve
 - Δ VHH = inlet key valve & outlet cascading dual check valve
 - **VHC = inlet key valve & outlet cartridge dual check valve
 - VB = inlet ball valve & no outlet valve
 - ***VBB = inlet ball valve & outlet ball valve
 - VBG = inlet ball valve & outlet compression valve
 - VBH = inlet ball valve & outlet single check valve
 - Δ VBHH = inlet ball valve & outlet cascading dual check valve
 - **VBHC = inlet ball valve & outlet cartridge dual check valve
- * Coppersettors can be ordered less valves by omitting the above letters from the catalog number.
- ** Cartridges with enhanced chlorine/ chloramine resistance are available. Add "CR" to end of alpha code.
Example: VHCCR72-15W-44-33-NL
- *** The 5/8" port angle ball valve is a one-way directional valve designed for the inlet side of the meter and should not be used as a customer shut-off on the customer side of the meter.

Meter size

- 1 = 5/8" meter
- 2 = 5/8"x 3/4" meter
- 3 = 3/4" meter
- 4 = 1" meter
- 6 = 1-1/2" flanged meter
- 7 = 2" flanged meter

**Ford Coppersetter
Numbering System**

Setter height (Approximate)

- 7 = 7" high setter
 - 8 = 8" high setter
 - 9 = 9" high setter
 - 10 = 10" high setter
 - 12 = 12" high setter
- Setters above 12" are made in 3" increments

Service line connection size

- | | Inlet | Outlet |
|---|--------|--------|
| 1 | 1/2" | |
| 3 | 3/4" | |
| 4 | 1" | |
| 5 | 1-1/4" | |
| 6 | 1-1/2" | |
| 7 | 2" | |

5/8" thru 1" Coppersettors only

W = Angle Meter Ball and Key Valves are with Padlock Wing

Compression valve without Padlock Wing

1-1/2" and 2" Coppersettors only

- B = Bypass
- HB = High Bypass
- BHC = Bypass with dual check (1-1/2" and 2" only)
- HBHC = High Bypass with dual check (1-1/2" and 2" only)

V72 - 12W - 44 - 33 - G - NL

Type of setter

- 3 = 30 series flexible resetter to use when meter nuts are available in existing services for 5/8", 5/8"x3/4", 3/4" and 1" meter
- 4 = 40 series resetter to use when meter connections are available in existing services
- 7 = 70 series coppersetter with horizontal inlet and outlet
- 7-8 = 70-80 series coppersetter with vertical inlet and horizontal outlet
- 8 = 80 series coppersetter with vertical inlet and outlet
- 9 = 90 series coppersetter with horizontal inlet and outlet for 5/8", 5/8" x 3/4", 3/4" and 1" meter
- 27 = 270 series coppersetter with detachable pack joint assemblies for 5/8", 5/8" x 3/4", 3/4" and 1" meter

Service line connection type

- 1 = Double Purpose Union Swivel (FIP for 1-1/2" & 2" Coppersettors)
- 2 = Flare Copper
- 4 = Pack Joint for CTS
- 6 = Pack Joint for PE pipe
- 7 = Pack Joint for PVC pipe (Schedule 40 & 80)
- 8 = Male Iron Pipe Union Swivel
- F = Integral Female Iron pipe (Female iron pipe union swivel may be used when integral FIP is not available.)
- M = Integral Male Iron Pipe Thread

Options

- G = Grip nut compression fitting instead of pack joint nut. Available with CTS (3/4" - 2") and PE Pipe (3/4" & 1")
- Q = Quick Joint
- TP6 = 1-1/2" Integral Test Port on Dual Check Valve for 1-1/2" and 2" Coppersettors with a shut-off valve below the Dual Check Valve
- TW-Q = CTS Quick Joint with Tracer Wire Terminal Ultra-Tite available with 3/4" and 1" CTS and PE Pipe (contact factory for pricing)
- U = Ultra-Tite available with 3/4" and 1" CTS and PE pipe where listed

90 Series Options

- A = 15" Outlet Extension
- B = 18" Outlet Extension
- C = Bolted Clamp
- E = Brace Eye
- F = 15" Outlet Extension and Bolted Clamp
- H = 15" Outlet Extension and Brace Eye
- J = 18" Outlet Extension and Bolted Clamp
- K = 18" Outlet Extension and Brace Eye

-NL = No Lead alloy ▲

Δ Angle cascading dual check valve contains 3/4" internal components. This valve meets the ASSE flow requirements of a 1" valve. For a full port valve, order the cartridge style check valve.

Note: 5/8" x 3/4", 3/4" and 1" setters with angle ball valve will have a reduced port that usually provides suitable water flow. A full port ball valve is available at an additional cost; add "-FP" to end of catalog number and contact the factory for pricing.

▲ Ford Meter Box no-lead brass products manufactured from UNS/CDA No. 89833 alloy shall contain no more than 0.25% total lead content by weight. United States federal and state laws allow the use of products manufactured from UNS C83600 85-5-5-5 brass alloy for only non-potable water systems within the United States.

Parties responsible for monitoring and maintaining proper water system design must exercise full responsibility in understanding and upholding the full intent and scope of applicable lead laws.

Information

Features of Ford Coppersetters, Linesetters and Resetters

Ford® Setter Benefits

Coppersetters, Linesetters, and Resetters are complete meter setting devices, easily installed and providing these permanent benefits.

- All Ford Meter Setters are assembled using lead-free solder
- Meter reading is expedited
- Pressure loss is minimized
- Meter changes are quick and do not disturb the service line
- Provides cost savings in couplings, valves, pipe fittings and labor
- Makes retrofitting a check valve for backflow prevention quick and easy

Coppersetters place meters 7" or more above the service line. Linesetters place meters 3" above the service line. We offer a wide variety of valve and service line connections. Resetters attach to old meter connections to raise and improve meter settings.



Valve Options - The valve on the riser of a Coppersetter, Linesetter or Resetter serves as a curb stop. An inverted key valve is available; however, angle ball valves and full port angle ball valves may be specified and provide many advantages. Padlock wings are standard on all Ford meter valves (key and ball styles). Ball Valves have an option for 360° rotation of the tee-head; insert "R" into the catalog number (Example: VB72-7WR-11-33-NL). 5/8" x 3/4", 3/4" and 1" Coppersetters with angle ball valve will be reduced port, unless otherwise specified. (Add "-FP" to the catalog number for full port.)



Angle Ball Valve

Dual Angle Check Valves are available on Ford setters and resetters for meters through 2". Cartridge Style Dual Angle Check Valves are available through 1". Located at the outlet of the meter, they are practical and inexpensive solutions to several potential backflow problems.

Pit flooding during meter changeouts is prevented, as well as hot water damage to meter chambers. In the event of a utility system pressure drop, some protection is afforded from cross-connection contamination, and raw water infiltration from customer well systems is minimized.

Checks are spring loaded, made of brass, plastic and stainless steel construction, and have a removable top or back cap for in-line maintenance purposes.

A single angle check valve can also be specified and ordered on any Ford Setter or Resetter. Check Valves are available as outlet valves. Ford is the choice of Dual Checks for Water Utilities. Only Ford offers these important advantages:

- The first full line of ASSE approved Dual Checks designed for use at the water meter
- The first full line of ASSE approved Dual Checks with removable access caps for easy maintenance
- The first ASSE approved Dual Checks available as integral parts of Coppersetters, Resetters and Yokes

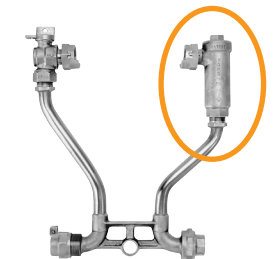

Cartridge Dual Check Valve



Saddle Nuts - Provide a supporting lip on the coupling nuts to hold the meter when it is lowered into position. Threads in the nuts are automatically lined up with the meter spuds for easy starting. Gaskets are held in place and prevented from dropping while the nuts are started. Saddle nuts save time, trouble and gaskets with each meter change.

Saddle nuts are included with all 5/8" through 1" Ford Coppersetters and Resetters (except Tandem Setters) as a free and valuable bonus. Support brackets included on 1-1/2" and 2" Coppersetters and Resetters provide similar advantages by holding the flanged meter and gasket in place while the flange bolts are inserted and tightened.

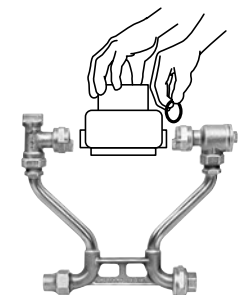

A **Compression Valve** is available on Coppersetters. It is normally placed at the outlet and is convenient for customer operation.



Compression Valve

A **Drain or Test Valve** for checking meter performance or draining service lines can be included at the outlet of plain or single valve Coppersetters and Resetters. The drain valve consists of a bronze body with a bronze screw seating on a plastic washer to prevent leakage.



Drain or Test Valve

Information

Setter Service Line Connections

Coppersettors are available with connections for a wide range of types and sizes of pipe and tubing. Note the convenience of Pack Joints, Grip Joints, Quick Joints and Ultra-Tites for existing services and for many new settings. Both Coppersettors and Resettors can be tailored to special conditions. Contact factory for assistance in creating a setter that will fit your needs.

Pack Joint, Quick Joint, Grip Joint and Ultra-Tite Compression Connections

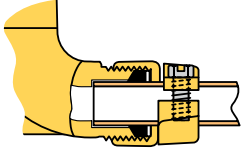

Pack Joint compression coupling for Copper, PET, PEP and PVC

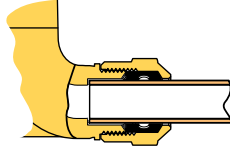

Quick Joint compression coupling for Copper, PET and PEP

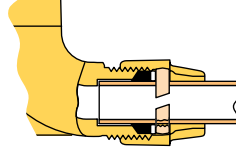

Grip Joint compression coupling for Copper, PET and PEP

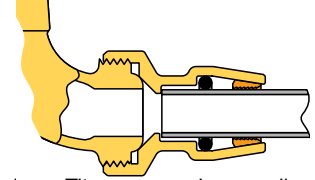

Ultra-Tite compression coupling for PET and PEP

Double Purpose and Flare Connections

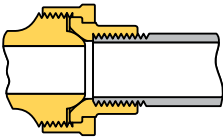

The Double Purpose Coupling as used for connection to male iron pipe threads

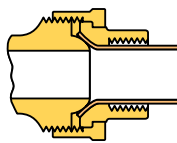

The Double Purpose Coupling as used for flare-type connection to copper

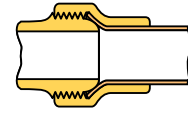

Flare Joint for connection to copper tubing

Swivel Iron Pipe Thread Connections

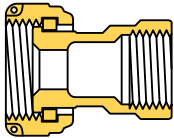

Union Nut and FIP Swivel Assembly for connecting smaller Coppersettors to male iron pipe threads

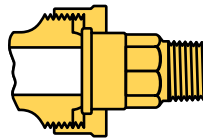

The Male Swivel is convenient for connecting to FIP adapters/valves

MIP Connections

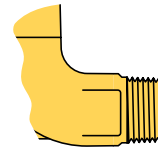

Integral Male Iron Pipe Thread (No Swivel)

270 Series Compression Connections

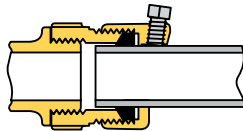

Pack Joint compression coupling for Iron Pipe

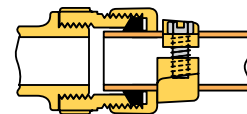

Pack Joint compression coupling for Copper, PET, PEP and PVC

GASKETS

Rubber gaskets are furnished with Coppersettors. Leather and composition gaskets are available upon request.

GASKETS FOR COPPERSETTERS LINESETTERS - RESETTERS

CATALOG NUMBER	MATERIAL	METER SIZE	DIAMETER		THICKNESS
			OUTSIDE	INSIDE	
GT-109	Composition	5/8"	15/16"	41/64"	1/8"
GT-116		5/8"x3/4" & 3/4"	1-5/32"	25/32"	1/8"
GT-121		1"	1-1/2"	1-1/16"	1/8"
GT-167	Leather (paraffined)	5/8"	15/16"	5/8"	1/8"
GT-113		5/8"x3/4" & 3/4"	1-3/16"	3/4"	1/8"
GT-163		1"	1-1/2"	1"	1/8"
GT-108	Rubber	5/8"	15/16"	5/8"	1/8"
GT-114		5/8"x3/4" & 3/4"	1-5/32"	3/4"	1/8"
GT-120		1"	1-1/2"	1"	1/8"
GT-205	Composition (for Double Purpose Connection)	3/4"	1-1/2"	1-3/16"	1/8"
GT-206		1"	1-7/8"	1-7/16"	1/8"

The Ford 70 Series Coppersetter

For 5/8", 5/8"x3/4", 3/4" or 1" Meters

Ford 70 series Coppersetters are designed to be a complete, ready-made meter setting. They require only two pipe joints to install and will connect to horizontal service lines. 70 Series Coppersetters are made in various heights to place the meter at the proper elevation for convenient reading and servicing. Correct hydraulic design ensures minimum pressure loss; copper and brass construction provides a lifetime of satisfactory service.

To order: Select one catalog number component from each of the three charts on pages 9 through 12 to arrive at the complete Coppersetter catalog number. Selection order of components:

- Step 1.** Meter size and valve type page 9
- Step 2.** Coppersetter height page 9
- Step 3.** Service line connections pages 10 -12

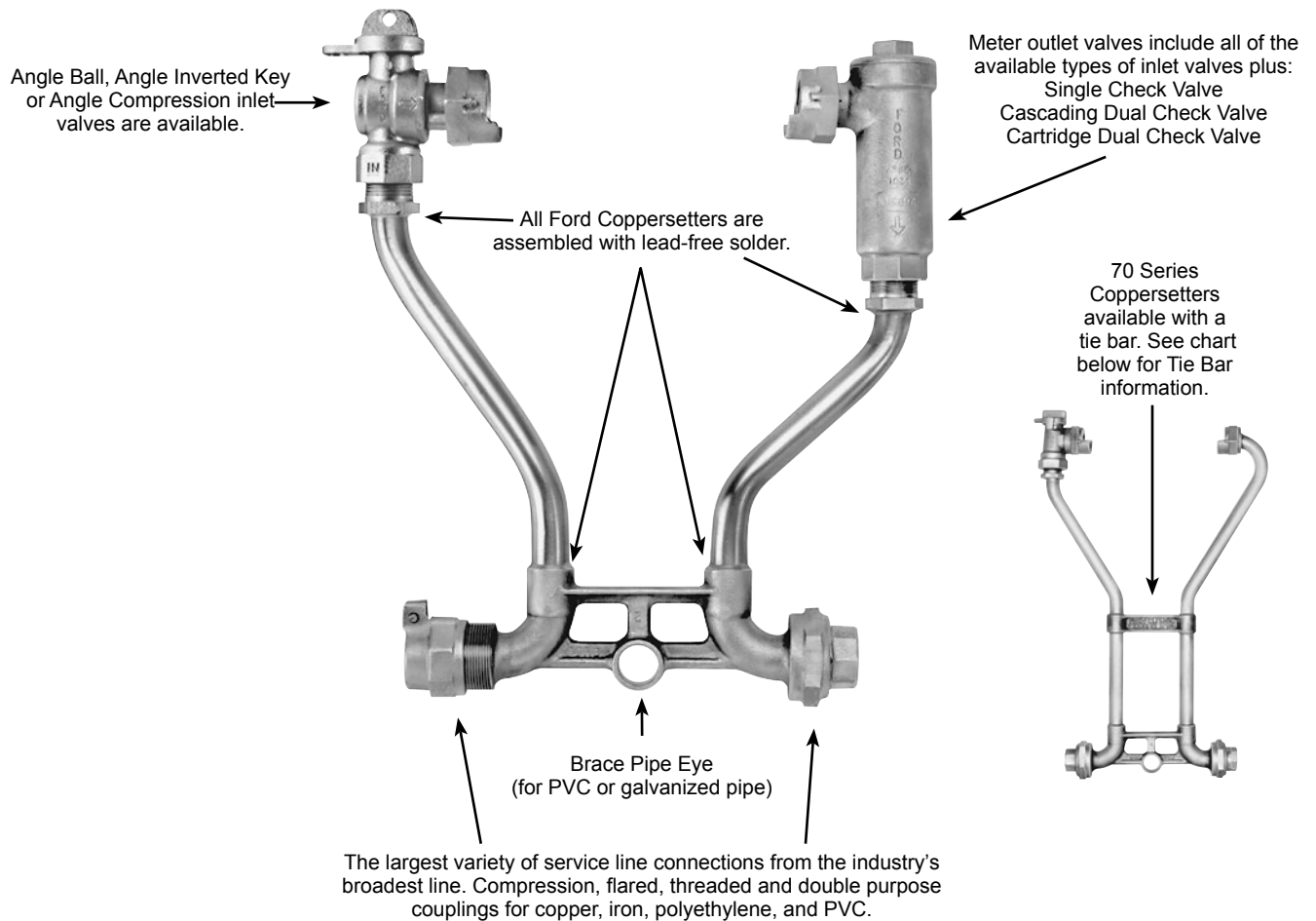

40, 70 AND 270 SERIES TIE BAR REQUIREMENTS				
COPPERSETTER HEIGHT	METER SIZE			
	5/8", 5/8"x3/4", & 3/4"		1"	
	WITHOUT *HHCA	WITH *HHCA	WITHOUT *HHCA	WITH *HHCA
15" & Under	NO	NO	NO	NO
18"	YES	NO	NO	NO
21"	YES	YES	YES	NO
24" thru 39"	YES	YES	YES	YES
42" and higher	YES (2)	YES (2)	YES (2)	YES (2)

* HHCA represents a cartridge style dual check valve, which is designated with an "HC" in the coppersetter catalog number. **Example:** VHC72-15W-44-33-NL

The Ford 70 Series Coppersetter

For 5/8", 5/8"x3/4", 3/4" or 1" Meters

Example of Catalog Number for a 70 Series Coppersetter

FIRST PART OF NUMBER
(meter size and valve type)

SECOND PART OF NUMBER
(coppersetter height)

THIRD PART OF NUMBER
(service line connection type and size)

VBHC72-12W-41-33-NL

Angle Ball Meter
Valve on inlet

Cartridge Angle Dual Check
on outlet

70 Series Coppersetter
For 5/8 x 3/4" meter only

Riser height is approximately 12" from
center line of the service line to center line
of the meter spud

(Brace eye is standard
on all 70 Series Coppersetters)

"No-Lead" Brass*

3/4" Outlet Service Line Connection

3/4" Inlet Service Line Connection

Double Purpose Union Swivel
Outlet Service Line Connection

Pack Joint for CTS

Inlet Service Line Connection

Angle Meter Ball and Key Valves are
with Padlock Wing – Compression valves
are **without** Padlock Wing

The description for the above catalog number reads: 70 Series Coppersetter for 5/8" x 3/4" meter with an Angle Ball Meter Valve on the inlet, Cartridge Angle Dual Check on the outlet, 12 inches high, with 3/4" Pack Joint for CTS inlet by 3/4" double purpose union swivel outlet.

* Ford Meter Box no-lead brass products manufactured from UNS/CDA No. 89833 alloy shall contain no more than 0.25% total lead content by weight. United States federal and state laws allow the use of products manufactured from UNS C83600 85-5-5 brass alloy for only non-potable water systems within the United States.

Catalog Numbering Illustration

METER SIZE & VALVE TYPE
1ST PART OF CATALOG NUMBER

HEIGHT
2ND PART OF
CATALOG NUMBER

SERVICE LINE CONNECTIONS
3RD PART OF CATALOG NUMBER

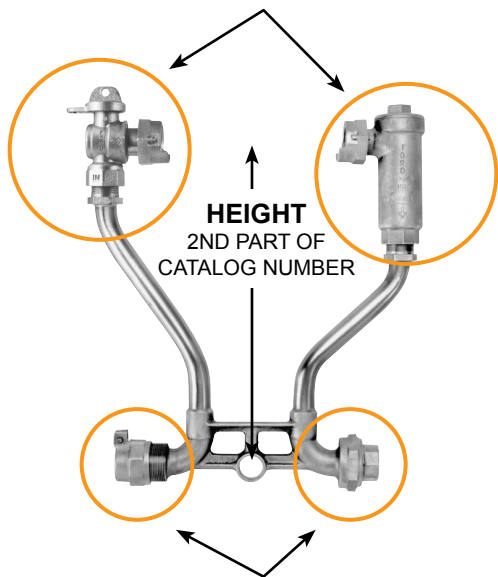

Dimensions

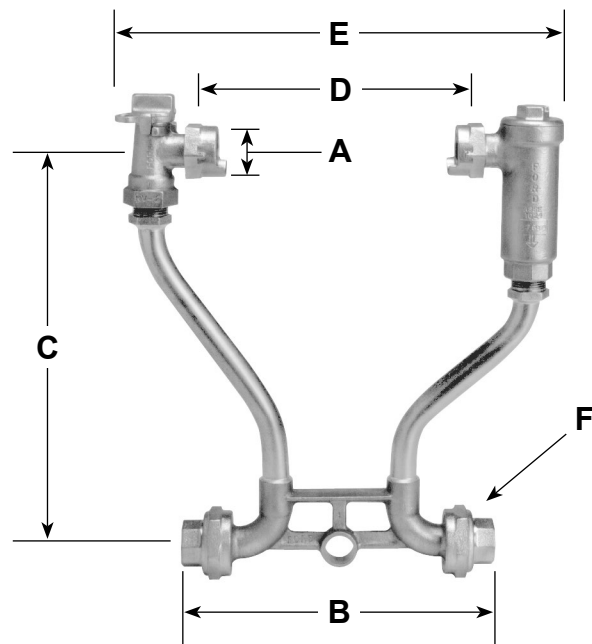

APPROX. DIMENSIONS	METER SIZES			
	5/8"	5/8" x 3/4"	3/4"	1"
A	1-1/16"	1-5/16"	1-5/16"	1-5/8"
B	9-1/2"	9-1/2"	11"	12-3/4"
C	Heights as ordered in all sizes			
D	7-1/2"+3/8"	7-1/2"+3/8"	9"+3/8"	10-3/4"+3/8"
E	12"	12"	14-1/4"	17-1/4"
F	3/4"	3/4"	3/4"	1"

The Ford 70 Series Coppersetter

For 5/8", 5/8"x3/4", 3/4" or 1" Meters

STEP 1. METER SIZE & VALVE TYPE - (FIRST PART OF CATALOG NUMBER)

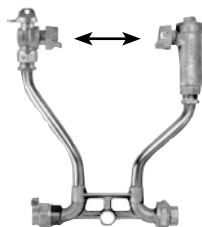

CATALOG NUMBER (METER SIZE AND VALVE TYPE)				DESCRIPTION (METER CONNECTION)	
FOR 5/8"	FOR 5/8"x 3/4"	FOR 3/4"	FOR 1"	INLET VALVE	OUTLET VALVE
71	72	73	74	None	None
V71	V72	V73	V74	Key	None
VB71	VB72	VB73	VB74	Ball	None
VBB71***	VBB72***	VBB73	VBB74	Ball	Ball
VV71	VV72	VV73	VV74	Key	Key
VVG71*	VVG72*	VVG73*	VVG74*	Key	Compression
VH71	VH72	VH73	VH74	Key	Single Check
VHH71	VHH72	VHH73	VHH74 ▼	Key	Cascading Dual Check
VHC71**	VHC72**	VHC73**	VHC74**	Key	● Cartridge Dual Check
VBG71*	VBG72*	VBG73*	VBG74*	Ball	Compression
VBH71	VBH72	VBH73	VBH74	Ball	Single Check
VBHH71	VBHH72	VBHH73	VBHH74 ▼	Ball	Cascading Dual Check
VBHC71**	VBHC72**	VBHC73**	VBHC74**	Ball	● Cartridge Dual Check

* Compression valve does not have padlock wing.

** 70 Series Coppersetters with cartridge dual check valve have a 9" minimum height for 5/8" and 5/8" x 3/4" meters, and a 12" minimum height for 3/4" and 1" meters.

*** The 5/8" port angle ball valve is a one-way directional valve designed for the inlet side of the meter and should not be used as a customer shut-off on the customer side of the meter.

▼ Angle cascading dual check valves contain 3/4" internal components. This valve meets the ASSE flow requirements of a 1" valve. For a full port valve, order the cartridge style check valve.

● Cartridges with enhanced chlorine/chloramine resistance are available. Add "CR" to end of alpha code. Example: VHC**CR**72-15W-44-33-NL

Note: Setters with angle ball valve will be reduced port unless otherwise requested. Reduced port valves usually provide suitable water flow. (Add "-FP" to the catalog number for full port.)

Meter Valve Options for 70 Series Coppersetters: Seal wire hole in inlet valve, seal wire hole in check valve

STEP 2. HEIGHT - (SECOND PART OF CATALOG NUMBER)

NOTE: Height dimensions are approximate.

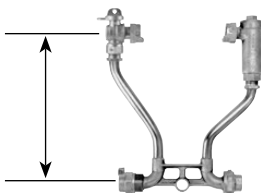

For 5/8" and 5/8"x3/4" Meter

CATALOG NUMBER	HEIGHT IN INCHES
7W-NL	7
9W-NL	9
12W-NL	12
15W-NL	15
18W-NL	18
21W-NL	21
24W-NL	24

For 3/4" Meter

CATALOG NUMBER	HEIGHT IN INCHES
8W-NL	8
12W-NL	12
15W-NL	15
18W-NL	18
21W-NL	21
24W-NL	24

For 1" Meter

CATALOG NUMBER	HEIGHT IN INCHES
10W-NL	10
12W-NL	12
15W-NL	15
18W-NL	18
21W-NL	21
24W-NL	24

HEIGHT INFORMATION FOR 70 SERIES COPPERSETTERS:

- Contact factory for availability of heights not listed.
- Coppersetters are available in heights over 24" in 3" increments; 27", 30", 33" etc. To order, place desired height in catalog number. Example: V72-33W-11-33-NL is a 33" high setter.
- See table on page 8 for tie bar requirements

The Ford 70 Series Coppersetter

For 5/8", 5/8"x3/4" and 3/4" Meters

STEP 3. INLET & OUTLET SERVICE LINE CONNECTIONS / BOTTOM BAR - (THIRD PART OF CATALOG NUMBER)

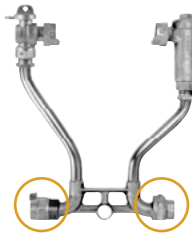

Service Line Connections

Pack Joint by Pack Joint		
CATALOG NUMBER	DESCRIPTION	
	INLET CONNECTION	OUTLET CONNECTION
▶♦ 44-33-NL	3/4" P.J. for Copper or Plastic Tubing (CTS)*	3/4" P.J. for Copper or Plastic Tubing (CTS)*
▶• 46-33-NL	3/4" P.J. for Copper or Plastic Tubing (CTS)*	3/4" P.J. for PE Pipe*
▶• 47-33-NL	3/4" P.J. for Copper or Plastic Tubing (CTS)*	3/4" P.J. for PVC Pipe
▶• 64-33-NL	3/4" P.J. for PE Pipe (PEP)	3/4" P.J. for Copper or Plastic Tubing (CTS)*
▶♦♦ 66-33-NL	3/4" P.J. for PE Pipe*	3/4" P.J. for PE Pipe*
▶• 74-33-NL	3/4" P.J. for PVC Pipe	3/4" P.J. for Copper or Plastic Tubing (CTS)*
• 77-33-NL	3/4" P.J. for PVC Pipe	3/4" P.J. for PVC Pipe
•♦ 44-43-NL	1" P.J. for Copper or Plastic Tubing (CTS)*	3/4" P.J. for Copper or Plastic Tubing (CTS)*
▶♦♦ 44-44-NL	1" P.J. for Copper or Plastic Tubing (CTS)*	1" P.J. for Copper or Plastic Tubing (CTS)*
▶• 46-44-NL	1" P.J. for Copper or Plastic Tubing (CTS)*	1" P.J. for PE Pipe*
▶• 47-44-NL	1" P.J. for Copper or Plastic Tubing (CTS)*	1" P.J. for PVC Pipe
▶• 64-44-NL	1" P.J. for PE Pipe*	1" P.J. for Copper or Plastic Tubing (CTS)*
▶• 66-44-NL	1" P.J. for PE Pipe*	1" P.J. for PE Pipe*
▶• 67-44-NL	1" P.J. for PE Pipe*	1" P.J. for PVC Pipe
▶• 74-44-NL	1" P.J. for PVC Pipe	1" P.J. for Copper or Plastic Tubing (CTS)*
▶• 76-44-NL	1" P.J. for PVC Pipe	1" P.J. for PE Pipe*
• 77-44-NL	1" P.J. for PVC Pipe	1" P.J. for PVC Pipe

Pack Joint by Iron Pipe and Double Purpose Connections		
♦ 4M-33-NL	3/4" P.J. for Copper or Plastic Tubing (CTS)*	3/4" Integral Male Iron Pipe Thread
▶♦ 14-33-NL	3/4" Double Purpose Union Swivel Δ	3/4" P.J. for Copper or Plastic Tubing (CTS)*
▶• 16-33-NL	3/4" Double Purpose Union Swivel Δ	3/4" P.J. for PE Pipe*
• 17-33-NL	3/4" Double Purpose Union Swivel Δ	3/4" P.J. for PVC Pipe
▶♦ 41-33-NL	3/4" P.J. for Copper or Plastic Tubing (CTS)*	3/4" Double Purpose Union Swivel Δ
▶♦ 48-33-NL	3/4" P.J. for Copper or Plastic Tubing (CTS)*	3/4" Male Iron Pipe Union Swivel
▶• 61-33-NL	3/4" P.J. for PE Pipe*	3/4" Double Purpose Union Swivel Δ
▶• 68-33-NL	3/4" P.J. for PEP Pipe*	3/4" Male Iron Pipe Union Swivel
• 71-33-NL	3/4" P.J. for PVC Pipe	3/4" Double Purpose Union Swivel Δ
• 78-33-NL	3/4" P.J. for PVC Pipe	3/4" Male Iron Pipe Union Swivel
▶♦ 84-33-NL	3/4" Male Iron Pipe Union Swivel	3/4" P.J. for Copper or Plastic Tubing (CTS)*
• 86-33-NL	3/4" Male Iron Pipe Union Swivel	3/4" P.J. for PEP Pipe*
• 87-33-NL	3/4" Male Iron Pipe Union Swivel	3/4" P.J. for PVC Pipe
♦♦ 48-34-NL	3/4" P.J. for Copper or Plastic Tubing (CTS)*	1" Male Iron Pipe Union Swivel
♦♦ 84-43-NL	1" Male Iron Pipe Union Swivel	3/4" P.J. for Copper or Plastic Tubing (CTS)*
• 4F-44-NL	1" P.J. for Copper or Plastic Tubing (CTS)*	1" Female Iron Pipe Union Swivel
• 6F-44-NL	1" P.J. for PE Pipe*	1" Female Iron Pipe Union Swivel
• 7F-44-NL	1" P.J. for PVC Pipe	1" Female Iron Pipe Union Swivel
• F4-44-NL	1" Female Iron Pipe Union Swivel	1" P.J. for Copper or Plastic Tubing (CTS)*
• F6-44-NL	1" Female Iron Pipe Union Swivel	1" P.J. for PE Pipe*
• F7-44-NL	1" Female Iron Pipe Union Swivel	1" P.J. for PVC Pipe
• 14-34-NL	3/4" Double Purpose Union Swivel Δ	1" P.J. for Copper or Plastic Tubing (CTS)*
• 16-34-NL	3/4" Double Purpose Union Swivel Δ	1" P.J. for PE Pipe*
• 17-34-NL	3/4" Double Purpose Union Swivel Δ	1" P.J. for PVC Pipe
• 41-43-NL	1" P.J. for Copper or Plastic Tubing (CTS)*	3/4" Double Purpose Union Swivel Δ
▶• 48-44-NL	1" P.J. for Copper or Plastic Tubing (CTS)*	1" Male Iron Pipe Union Swivel
• 61-43-NL	1" P.J. for PE Pipe*	3/4" Double Purpose Union Swivel Δ
• 71-43-NL	1" P.J. for PVC Pipe	3/4" Double Purpose Union Swivel Δ
• 78-44-NL	1" P.J. for PVC Pipe	1" Male Iron Pipe Union Swivel
▶• 84-44-NL	1" Male Iron Pipe Union Swivel	1" P.J. for Copper or Plastic Tubing (CTS)*
• 87-44-NL	1" Male Iron Pipe Union Swivel	1" P.J. for PVC Pipe

* **Grip Joint** for CTS and PE pipe is available. Add "-G" to the catalog number.
Example: V72-12W-41-33-G-NL

♦ **Quick Joint** is available. Add "-Q" to the catalog number.

▶ **Ultra-Tite** is available. Contact factory for more information.

Δ Double Purpose Union Swivels will accommodate male iron pipe threads or flare copper.

• These connections on 73 Series Coppersettors will have 13/16" O.D. copper tubing.

NOTE: Ford Pack Joints for PVC are recommended for Schedule 40 and Schedule 80 pipe only.

The Ford 70 Series Coppersetter

For 5/8", 5/8"x3/4" and 3/4" Meters

STEP 3. INLET & OUTLET SERVICE LINE CONNECTIONS / BOTTOM BAR - (THIRD PART OF CATALOG NUMBER)

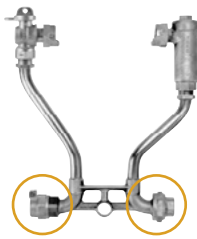

Service Line Connections

Double Purpose, Iron Pipe and Flare Copper		
CATALOG NUMBER	DESCRIPTION	
	INLET CONNECTION	OUTLET CONNECTION
11-33-NL	3/4" Double Purpose Union Swivel Δ	3/4" Double Purpose Union Swivel Δ
18-33-NL	3/4" Double Purpose Union Swivel Δ	3/4" Male Iron Pipe Union Swivel
21-33-NL	3/4" Flare Copper	3/4" Double Purpose Union Swivel Δ
22-33-NL	3/4" Flare Copper	3/4" Flare Copper
88-33-NL	3/4" Male Iron Pipe Union Swivel	3/4" Male Iron Pipe Union Swivel
81-33-NL	3/4" Male Iron Pipe Union Swivel	3/4" Double Purpose Union Swivel Δ
• FF-33-NL	3/4" Integral Female Iron Pipe	3/4" Integral Female Iron Pipe
MM-33-NL	3/4" Integral Male Iron Pipe	3/4" Integral Male Iron Pipe
81-43-NL	1" Male Iron Pipe Union Swivel	3/4" Double Purpose Union Swivel Δ
FF-44-NL	1" Female Iron Pipe Union Swivel	1" Female Iron Pipe Union Swivel
11-44-NL	1" Double Purpose Union Swivel Δ	1" Double Purpose Union Swivel
22-44-NL	1" Flare Copper	1" Flare Copper
88-44-NL	1" Male Iron Pipe Union Swivel	1" Male Iron Pipe Union Swivel

Δ Double Purpose Union Swivels will accommodate male iron pipe threads or flare copper.

- These connections on 73 Series Coppersetters will have 13/16" O.D. copper tubing.

PARTS FOR 5/8", 5/8" X 3/4" AND 3/4" SERIES COPPERSETTERS

CATALOG NUMBER	DESCRIPTION	APPROX. Wt. LBS.
■ CSUN-3	Union Nut only	0.2
CSS1-33-NL	3/4" Female Iron Pipe Thread Swivel only	0.2
○ CSSS-33-CR-NL	3/4" Solder Swivel only	0.2
CSS4-33-NL	3/4" CTS Pack Joint Swivel only (with Pack Joint Nut)	0.7
CSS8-33-NL	3/4" Male Iron Pipe Thread Swivel only	0.5
CSS8-34-NL	1" Male Iron Pipe Thread Swivel only	0.4
○ CSSS-34-CR-NL	1" Solder Swivel only	0.2
CSSUN1-33-NL	3/4" Female Iron Pipe Swivel and Union Nut Assembly	0.4
CSSUN1-34-NL	1" Female Iron Pipe Thread Swivel and Union Nut Assembly	0.9
CSSUN4-33-NL	3/4" CTS Pack Joint Swivel and Union Nut Assembly	0.9
CSSUN4-33-Q-NL	3/4" CTS Quick Joint Swivel and Union Nut Assembly (with Quick Joint Nut)	1.1
CSSUN4-34-Q-NL	1" CTS Quick Joint Swivel and Union Nut Assembly	1.5
CSA4-33-U-NL	3/4" Female Double Purpose by 3/4" CTS Ultra-Tite	0.7
CSA4-44-U-NL	1" Female Double Purpose by 1" CTS Ultra-Tite	0.9
CSA6-33-U-NL	3/4" Female Double Purpose by 3/4" PEP Ultra-Tite	0.8
CSA6-44-U-NL	1" Female Double Purpose by 1" PEP Ultra-Tite	1.0
CSA4-33-Q-NL	3/4" CTS Quick Joint Adapter for 3/4" Double Purpose Nose	1.0
CSA7-33-NL	3/4" Pack Joint for PVC for 3/4" Double Purpose	1.1
HHSCS8-333-NL	3/4" Dual Check Valve with Valve Copperhorn Union Swivel Inlet and 3/4" MIP Outlet (Unit attaches directly to setter bottom bar)	1.8
GT-205	3/4" Composition Gasket for Double Purpose Connection	-
GT-206	1" Composition Gasket for Double Purpose Connection	-

NOTE: Ford Pack Joints for PVC are recommended for Schedule 40 and Schedule 80 pipe only.

- **Attention:** Special solder and procedures are required for best results. Contact factory or see website for installation instructions.

- Item does not come in contact with potable water and is manufactured of UNS/CDA No. C83600 alloy.

The Ford 70 Series Coppersetter

For 1" Meters

STEP 3. INLET & OUTLET SERVICE LINE CONNECTIONS / BOTTOM BAR - (THIRD PART OF CATALOG NUMBER)

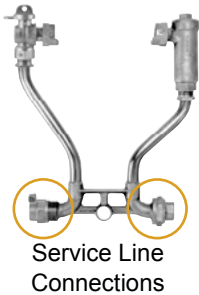

Pack Joint by Pack Joint		
CATALOG NUMBER	DESCRIPTION	
	INLET CONNECTION	OUTLET CONNECTION
▶♦ 44-44-NL	1" P.J. for Copper or Plastic Tubing (CTS)*	1" P.J. for Copper or Plastic Tubing (CTS)*
▶ 46-44-NL	1" P.J. for Copper or Plastic Tubing (CTS)*	1" P.J. for PE Pipe*
▶ 47-44-NL	1" P.J. for Copper or Plastic Tubing (CTS)*	1" P.J. for PVC Pipe
▶ 64-44-NL	1" P.J. for PE Pipe*	1" P.J. for Copper or Plastic Tubing (CTS)*
▶ 66-44-NL	1" P.J. for PE Pipe*	1" P.J. for PE Pipe*
▶ 67-44-NL	1" P.J. for PE Pipe*	1" P.J. for PVC Pipe
▶ 74-44-NL	1" P.J. for PVC Pipe	1" P.J. for Copper or Plastic Tubing (CTS)*
▶ 76-44-NL	1" P.J. for PVC Pipe	1" P.J. for PE Pipe*
▶ 77-44-NL	1" P.J. for PVC Pipe	1" P.J. for PVC Pipe

Pack Joint, Iron Pipe Thread and Double Purpose Connections		
▶♦ 14-44-NL	1" Double Purpose Union Swivel Δ	1" P.J. for Copper or Plastic Tubing (CTS)*
▶ 16-44-NL	1" Double Purpose Union Swivel Δ	1" P.J. for PE Pipe*
▶ 17-44-NL	1" Double Purpose Union Swivel Δ	1" P.J. for PVC Pipe
▶♦ 41-44-NL	1" P.J. for Copper or Plastic Tubing (CTS)*	1" Double Purpose Union Swivel Δ
▶ 48-44-NL	1" P.J. for Copper or Plastic Tubing (CTS)*	1" Male Iron Pipe Union Swivel
▶ 61-44-NL	1" P.J. for PE Pipe*	1" Double Purpose Union Swivel Δ
▶ 71-44-NL	1" P.J. for PVC Pipe	1" Double Purpose Union Swivel Δ
▶ 84-44-NL	1" Male Iron Pipe Union Swivel	1" P.J. for Copper or Plastic Tubing (CTS)*
▶ FF-44-NL	1" Female Iron Pipe Union Swivel	1" Female Iron Pipe Union Swivel

Iron Pipe and Flare Connections		
▶ 11-44-NL	1" Double Purpose Union Swivel Δ	1" Double Purpose Union Swivel Δ
▶ 12-44-NL	1" Double Purpose Union Swivel Δ	1" Flare Copper
▶ 18-44-NL	1" Double Purpose Union Swivel Δ	1" Male Iron Pipe Union Swivel
▶ 21-44-NL	1" Flare Copper	1" Double Purpose Union Swivel Δ
▶ 22-44-NL	1" Flare Copper	1" Flare Copper
▶ 28-44-NL	1" Flare Copper	1" Male Iron Pipe Union Swivel
▶ 81-44-NL	1" Male Iron Pipe Union Swivel	1" Double Purpose Union Swivel Δ
▶ 82-44-NL	1" Male Iron Pipe Union Swivel	1" Flare Copper
▶ 88-44-NL	1" Male Iron Pipe Union Swivel	1" Male Iron Pipe Union Swivel
▶ MM-44-NL	1" Integral Male Iron Pipe	1" Integral Male Iron Pipe
▶ 88-55-NL	1-1/4 Male Iron Pipe Union Swivel	1-1/4 Male Iron Pipe Union Swivel
▶ FF-55-NL	1-1/4 Female Iron Pipe Union Swivel	1-1/4 Female Iron Pipe Union Swivel
▶ MM-66-NL	1-1/2" Integral Male Iron Pipe	1-1/2" Integral Male Iron Pipe

PARTS FOR 1" SERIES COPPERSETTERS

CATALOG NUMBER	DESCRIPTION	APPROX. WT. LBS.
CSA4-44-U-NL	1" Ultra-Tite by Pack Joint (CTS) by 1" Double Purpose	0.9
CSA6-44-U-NL	1" Ultra-Tite by Pack Joint (PEP) by 1" Double Purpose	1.0
CSA7-44-NL	1" Pack Joint PVC Adapter for Double Purpose Nose	2.0
▣ CSUN-4	Union Nut only	0.4
CSS1-44-NL	1" Female Iron Pipe Thread Swivel only	0.3
CSS8-44-NL	1" Male Iron Pipe Thread Swivel only	0.5
CSS8-45-NL	1-1/4" Male Iron Pipe Thread Swivel only	0.7
○ CSSS-44-CR-NL	1" Solder Swivel only	0.3
CSSUN1-44-NL	1" Female Iron Pipe Thread Swivel and Union Nut Assembly	0.7

○ **Attention:** Special solder and procedures are required for best results. Contact factory or see website for installation instructions.

* **Grip Joint** for CTS and PE pipe is available. Add "-G" to the catalog number.

♦ **Quick Joint** is available. Add "-Q" to the catalog number.

▶ **Ultra-Tite** is available. Contact factory for more information.

Δ Double Purpose Union Swivels will accommodate male iron pipe threads or flare copper.

▣ Item does not come in contact with potable water and is manufactured of UNS/CDA No. C83600 alloy.

NOTE: Ford Pack Joints for PVC are recommended for Schedule 40 and Schedule 80 pipe only.

The Ford 270 Series Coppersetter

For 5/8", 5/8"x3/4", 3/4" or 1" Meter Size

Requires removable Pack Joint Assemblies (Assemblies ordered separately)

The 270 Series Coppersetter, with removable Pack Joint Assemblies, save time and expense when water meters are set outside in existing service lines. Threading of old iron pipe or flaring of brittle copper tubing is not required. Pack Joint Assemblies are interchangeable and available for all types of service pipe; a great help in metering programs where conditions are unknown until the pits are dug.

To order: Select one Catalog Number component from each of the charts on pages 14 and 15 to arrive at the complete Coppersetter Catalog Number. Additionally, removable Pack Joint Assemblies are available and are ordered and priced separately. Selection order of components:

- Step 1. Meter size and valve type page 14
- Step 2. Coppersetter height page 14
- Step 3. Service line connections (removable Pack Joint Assemblies). page 15

Example of Catalog Number for a 270 Series Coppersetter

FIRST PART OF NUMBER
(meter size and valve type)

SECOND PART OF NUMBER
(coppersetter height)

VBHC272-12W-NL

Angle Ball
Meter Valve on inlet

Cartridge Angle Dual Check
on outlet

270 Series Coppersetter
with detachable
Pack Joint Assemblies

For 5/8 x 3/4" meter only

"No-lead" brass*

Angle Meter Ball and Key Valves are **with** padlock wing - Compression valves are **without** padlock wing

12" Riser Height from Center Line of service line to center line of meter spud

The description for the above catalog number reads: A 12 inch high 270 Series Coppersetter for 5/8 x 3/4" meter with an Angle Ball Meter Valve inlet and a Cartridge Angle Dual Check on the outlet.

* Ford Meter Box no-lead brass products manufactured from UNS/CDA No. 89833 alloy shall contain no more than 0.25% total lead content by weight. United States federal and state laws allow the use of products manufactured from UNS C83600 85-5-5-5 brass alloy for only non-potable water systems within the United States.

Catalog Numbering

METER SIZE & VALVE TYPE
1ST PART OF CATALOG NUMBER

HEIGHT
2ND PART OF CATALOG NUMBER

SERVICE LINE CONNECTIONS

Removable Pack Joint Assemblies for copper, iron, polyethylene and PVC (ordered separately)

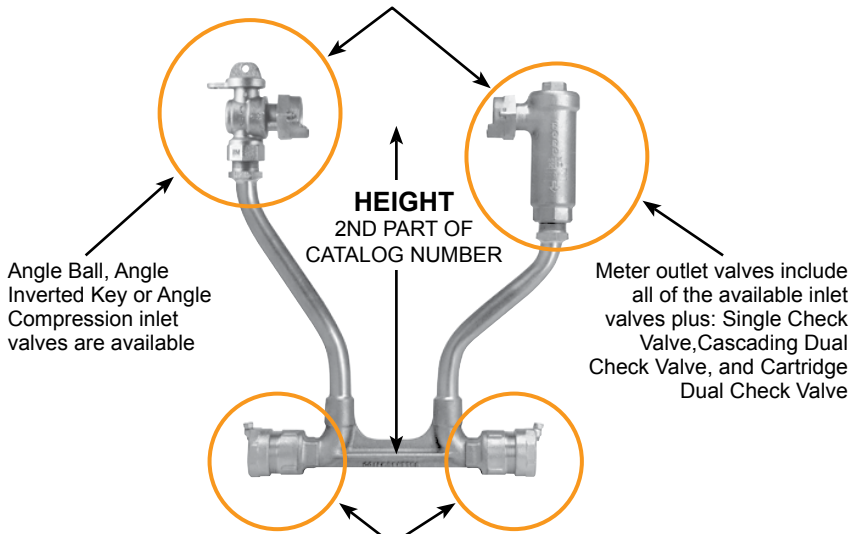

Installation

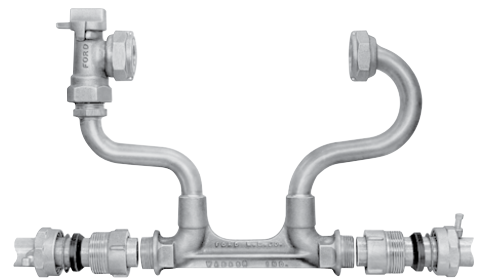

Quick and simple installation involves cutting out a section of service line about 1/2" longer than the Coppersetter bar, cleaning about 3" of pipe ends and slipping Pack Joint Assemblies onto pipe (as shown in photo above). The Pack Joint Assemblies are then screwed tightly onto the bar, and the nuts tightened and locked into place.

The Ford 270 Series Coppersetter

For 5/8", 5/8"x3/4", 3/4" or 1" Meter Size

Requires removable Pack Joint Assemblies (Assemblies ordered separately)

STEP 1. METER SIZE & VALVE TYPE - (FIRST PART OF CATALOG NUMBER)

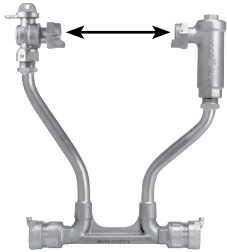

CATALOG NUMBER (METER SIZE AND VALVE TYPE)				DESCRIPTION	
FOR 5/8"	FOR 5/8"x 3/4"	FOR 3/4"	FOR 1"	INLET VALVE	OUTLET VALVE
271	272	273	274	None	None
V271	V272	V273	V274	Key	None
VB271	VB272	VB273	VB274	Ball	None
VBB271***	VBB272***	VBB273	VBB274	Ball	Ball
VV271	VV272	VV273	VV274	Key	Key
VVG271*	VVG272*	VVG273*	VVG274*	Key	Compression
VH271	VH272	VH273	VH274	Key	Single Check
VHH271	VHH272	VHH273	VHH274 ▼	Key	Cascading Dual Check
VHC271**	VHC272**	VHC273**	VHC274**	Key	• Cartridge Dual Check
VBG271*	VBG272*	VBG273*	VBG274*	Ball	Compression
VBH271	VBH272	VBH273	VBH274	Ball	Single Check
VBHH271	VBHH272	VBHH273	VBHH274 ▼	Ball	Cascading Dual Check
VBHC271**	VBHC272**	VBHC273**	VBHC274**	Ball	• Cartridge Dual Check

* Compression valve does not have padlock wing.

** 270 Series Coppersetters with cartridge dual check valve have a 9" minimum height for 5/8" and 5/8" x 3/4" meters, and a 12" minimum height for 3/4" and 1" meters.

*** The 5/8" port angle ball valve is a one-way directional valve designed for the inlet side of the meter and should not be used as a customer shut-off on the customer side of the meter.

▼ Angle Cascading Dual Check Valves contain 3/4" internal components. This valve meets the ASSE flow requirements of a 1" valve. For a full port valve, order the cartridge style check valve.

• Cartridges with enhanced chlorine/chloramine resistance are available. Add "CR" to end of alpha code. Example: VHCCR72-15W-NL

Note: Setters with angle ball valve will be reduced port unless otherwise requested. Reduced port valves usually provide suitable water flow. (Add "-FP" to catalog number for full port.)

Meter Valve Options for 270 Series Coppersetters: Seal wire hole in inlet valve, seal wire hole in check valve

STEP 2. HEIGHT - (SECOND PART OF CATALOG NUMBER)

NOTE: Height dimensions are approximate.

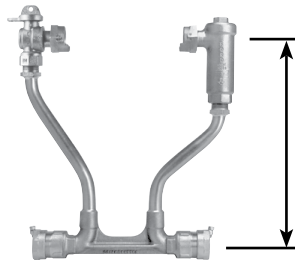

For 5/8" and 5/8"x3/4" Meter

CATALOG NUMBER	HEIGHT IN INCHES
7W-NL	7
9W-NL	9
12W-NL	12
15W-NL	15
18W-NL	18
21W-NL	21
24W-NL	24

For 3/4" Meter

CATALOG NUMBER	HEIGHT IN INCHES
8W-NL	8
12W-NL	12
15W-NL	15
18W-NL	18
21W-NL	21
24W-NL	24

For 1" Meter

CATALOG NUMBER	HEIGHT IN INCHES
10W-NL	10
12W-NL	12
15W-NL	15
18W-NL	18
21W-NL	21
24W-NL	24

HEIGHT INFORMATION FOR 270 SERIES COPPERSETTERS:

- Contact factory for availability of heights not listed.
- Coppersetters are available in heights over 24" in 3" increments; 27", 30", 33" etc. To order, put desired height in catalog number. Example: V272-30W-NL is a 30" high setter.
- See table on page 8 for Tie Bar requirements

The Ford 270 Series Coppersetter

For 5/8", 5/8"x3/4", 3/4" or 1" Meter Size

Requires removable Pack Joint Assemblies (Assemblies ordered separately)

PACK JOINT ASSEMBLIES FOR 270 SERIES COPPERSETTERS

STEP 3. INLET & OUTLET SERVICE LINE CONNECTIONS

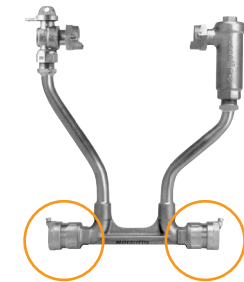

Pack Joint Assemblies
(ordered separately)
**Service Line
Connections**

CATALOG NUMBER	DESCRIPTION	
	SIZE AND TYPE OF EXISTING PIPE	P.J. ASSEMBLY REQUIRED
◆ PJA4-11-NL	1/2" Copper or Plastic Tube	1/2" Pack Joint for Copper or Plastic Tubing (CTS)*
◆ PJA4-13-NL	3/4" Copper or Plastic Tube	3/4" Pack Joint for Copper or Plastic Tubing (CTS)*
PJA4-14-NL	1" Copper or Plastic Tube	1" Pack Joint for Copper or Plastic Tubing (CTS)*
• PJA4-15-PJA6-14-NL	1-1/4" Copper or Plastic Tube	1-1/4" Pack Joint for Copper or Plastic Tubing (CTS)*
□ PJA4-16-AWT-NL	1-1/2" Copper or Plastic Tube	1-1/2" Pack Joint for Copper or Plastic Tubing (CTS)*
◆*** PJA4-44-C14-54-NL	1" Copper or Plastic Tube	1" Pack Joint for Copper or Plastic Tubing (CTS)*
◆*** PJA4-45-C14-55-NL	1-1/4" Copper or Plastic Tube	1-1/4" Pack Joint for Copper or Plastic Tubing (CTS)*
*** PJA4-46-C14-56-NL	1-1/2" Copper or Plastic Tube	1-1/2" Pack Joint for Copper or Plastic Tubing (CTS)*
PJA5-11-NL	1/2" Iron Pipe	1/2" Pack Joint for Iron Pipe
PJA5-13-NL	3/4" Iron Pipe	3/4" Pack Joint for Iron Pipe
PJA5-14-NL	1" Iron Pipe	1" Pack Joint for Iron Pipe
PJA5-15-NL	1-1/4" Iron Pipe	1-1/4" Pack Joint for Iron Pipe
□ PJA5-16-AWT-NL	1-1/2" Iron Pipe	1-1/2" Pack Joint for Iron Pipe
*** PJA5-44-C15-54-NL	1" Iron Pipe	1" Pack Joint for Iron Pipe
*** PJA5-45-C15-55-NL	1 1/4" Iron Pipe	1-1/4" Pack Joint for Iron Pipe
*** PJA5-46-C15-56-NL	1 1/2" Iron Pipe	1-1/2" Pack Joint for Iron Pipe
PJA6-13-NL	3/4" Polyethylene Pipe	3/4" Pack Joint for PE Pipe*
• PJA4-15-PJA6-14-NL	1" Polyethylene Pipe	1" Pack Joint for PE Pipe*
□ PJA6-15-AWT-NL	1-1/4" Polyethylene Pipe	1-1/4" Pack Joint for PE Pipe
□ PJA6-16-IDR7-AWT-NL	1-1/2" Polyethylene Pipe	1-1/2" Pack Joint for PE Pipe
*** PJA6-44-C16-54-NL	1" Polyethylene Pipe	1" Pack Joint for PE Pipe*
*** PJA6-45-C16-55-NL	1-1/4" Polyethylene Pipe	1-1/4" Pack Joint for PE Pipe
*** PJA6-46-C16-56-IDR7-NL	1-1/2" Polyethylene Pipe	1-1/2" Pack Joint for PE Pipe
PJA7-11-NL	1/2" PVC Pipe	1/2" Pack Joint for PVC Pipe
PJA7-13-NL	3/4" PVC Pipe	3/4" Pack Joint for PVC Pipe
PJA7-14-NL	1" PVC Pipe	1" Pack Joint for PVC Pipe
PJA7-15-NL	1-1/4" PVC Pipe	1-1/4" Pack Joint for PVC Pipe
□ PJA7-16-AWT-NL	1-1/2" PVC Pipe	1-1/2" Pack Joint for PVC Pipe
*** PJA7-44-C17-54-NL	1" PVC Pipe	1" Pack Joint for PVC Pipe
*** PJA7-45-C17-55-NL	1-1/4" PVC Pipe	1-1/4" Pack Joint for PVC Pipe
*** PJA7-46-C17-56-NL	1-1/2" PVC Pipe	1-1/2" Pack Joint for PVC Pipe

NOTE: Ford Pack Joints for PVC are recommended for Schedule 40 and Schedule 80 pipe only.

* **Grip Joint** for CTS (all sizes) and PE pipe (3/4" and 1") is available. Add "-G" to the catalog number.
Example: PJA4-13-G-NL

◆ **Quick Joint** is available. Add "-Q" to the catalog number.

□ These items are not one piece but are two adapter pieces assembled watertight.

*** These pack joint assemblies are for 1" 274 Series Coppersetters or KH-4-NL Kornerhorns, DH-4 Drophorns and PH-4 Pretzelhorns listed in catalog Section B.

• This pack joint assembly is for use on 1-1/4" copper or plastic tubing (CTS) or 1" PE Pipe

PACK JOINT ELL ASSEMBLIES 5/8", 5/8"x3/4" AND 3/4" 270 SERIES COPPERSETTERS (TWO REQUIRED PER COPPERSETTER)

CATALOG NUMBER	DESCRIPTION	
	SIZE AND TYPE OF EXISTING PIPE	P.J. ASSEMBLY REQUIRED
PJAL4-13-NL	3/4" Copper or Plastic Tube	3/4" Pack Joint for Copper or Plastic Tubing (CTS)*
PJAL6-13-NL	3/4" Polyethylene Pipe	3/4" Pack Joint for PE Pipe*

* **Grip Joint** for CTS and PE pipe (3/4" & 1") is available. Add "-G" to the catalog number. Example: PJAL4-13-G-NL

The Ford 80 Series Coppersetter

For 5/8", 5/8"x3/4", 3/4" or 1" Meter Size

Vertical Inlet and Outlet

The Ford 80 Series Coppersetter offers economy and flexibility by allowing the utility to construct meter pit risers from various service line materials, cut to any height. The 80 Series setters connect directly to these risers, without elbows or pressure reducing bends, by means of a wide variety of service line connections. All standard Coppersetter valve options, including dual or single Check Valves, are available on the 80 Series.

To order: Select one catalog number component from each of two charts on pages 17 and 18 to arrive at the complete Coppersetter catalog number. Selection order of components:

Step 1. Meter size and valve type page 17

Step 2. Service line connections page 18

Example of Catalog Number for an 80 Series Coppersetter

FIRST PART OF NUMBER
(meter size and valve type)

SECOND PART OF NUMBER
(service line connection type and size)

VBHC82W-44-33-NL

Angle Ball Meter Valve
on inlet

Cartridge Angle Dual Check
on outlet

80 Series Coppersetter

For 5/8" x 3/4" meter only

Angle Meter Ball and Key Valves are **with** Padlock Wing
Compression valves are **without** Padlock Wing

"No-lead" brass*

3/4" Outlet Service Line Connection

3/4" Inlet Service Line Connection

Pack Joint for CTS
Outlet Service Line Connection

Pack Joint for CTS
Inlet Service Line Connection

Approximate height for 5/8" & 5/8" x 3/4" meter is 7", for 3/4" meter 9", and for 1" meter 10"

The description for the above catalog number reads: 80 Series Coppersetter for 5/8" x 3/4" meter with an Angle Ball Meter Valve on the inlet, Cartridge Angle Dual Check on the outlet, with 3/4" Pack Joint for CTS inlet by 3/4" Pack Joint for CTS outlet service line connections.

* Ford Meter Box no-lead brass products manufactured from UNS/CDA No. 89833 alloy shall contain no more than 0.25% total lead content by weight. United States federal and state laws allow the use of products manufactured from UNS C83600 85-5-5-5 brass alloy for only non-potable water systems within the United States.

Catalog Numbering

METER SIZE & VALVE TYPE
1ST PART OF CATALOG NUMBER

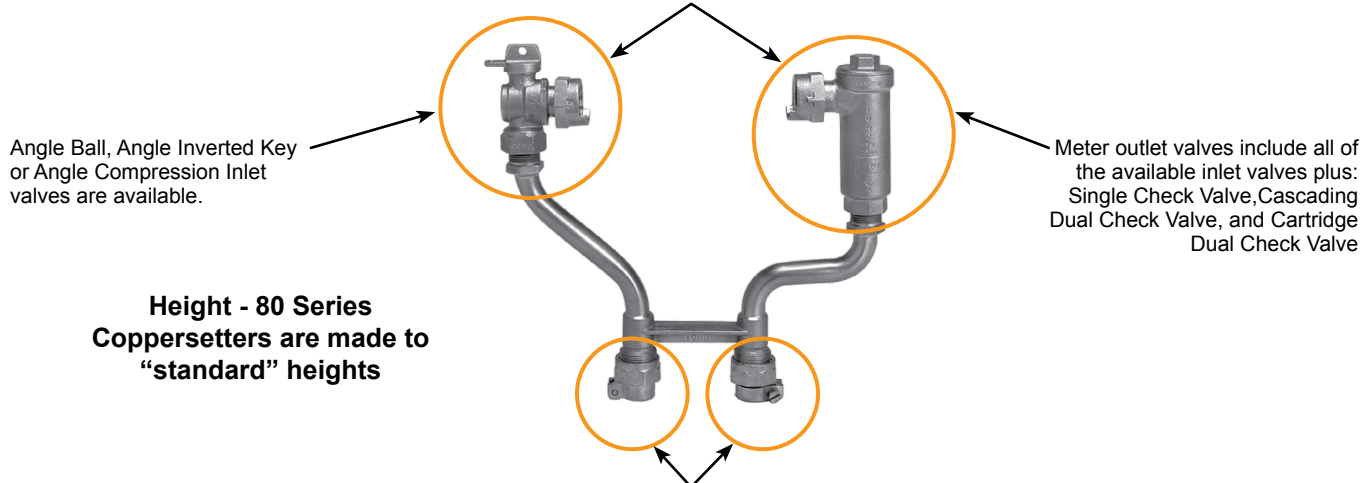

SERVICE LINE CONNECTIONS
2ND PART OF CATALOG NUMBER

The largest variety of service line connections in the waterworks industry. Compression, flared, threaded and double purpose couplings for copper, iron, polyethylene and PVC

The Ford 80 Series Coppersetter

For 5/8", 5/8"x3/4", 3/4" or 1" Meter Size

Vertical Inlet and Outlet

STEP 1. METER SIZE & VALVE TYPE - (FIRST PART OF CATALOG NUMBER)

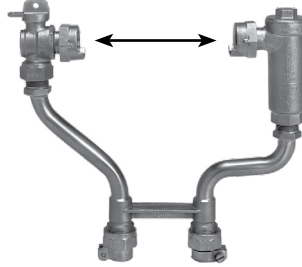

CATALOG NUMBER (METER SIZE AND VALVE TYPE)				DESCRIPTION	
FOR 5/8"	FOR 5/8"x 3/4"	FOR 3/4"	FOR 1"	INLET VALVE	OUTLET VALVE
V81	V82	V83	V84	Key	None
VB81	VB82	VB83	VB84	Ball	None
VBB81***	VBB82***	VBB83	VBB84	Ball	Ball
VVG81*	VVG82*	VVG83*	VVG84*	Key	Compression
VV81	VV82	VV83	VV84	Key	Key
VH81	VH82	VH83	VH84	Key	Single Check
VHH81	VHH82	VHH83	VHH84 ▼	Key	Cascading Dual Check
VHC81**	VHC82**	VHC83**	VHC84**	Key	● Cartridge Dual Check
VBH81	VBH82	VBH83	VBH84	Ball	Single Check
VBHH81	VBHH82	VBHH83	VBHH84 ▼	Ball	Cascading Dual Check
VBHC81**	VBHC82**	VBHC83**	VBHC84**	Ball	● Cartridge Dual Check

* Compression valve does not have padlock wing.

** 80 Series Coppersetters with cartridge dual check valve have a 9" minimum height for 5/8" and 5/8" x 3/4" meters, and a 12" minimum height for 3/4" and 1" meters.

*** The 5/8" port angle ball valve is a one-way directional valve designed for the inlet side of the meter and should not be used as a customer shut-off on the customer side of the meter.

▼ Angle Cascading Dual Check Valves contain 3/4" internal components. This valve meets the ASSE flow requirements of a 1" valve. For a full port valve, order the cartridge style check valve.

● Cartridges with enhanced chlorine/chloramine resistance are available. Add "CR" to end of alpha code. Example: VHCCR82W-44-33-NL

Note: Setters with angle ball valve will be reduced port unless otherwise requested. Reduced port valves usually provide suitable water flow. (Add "-FP" to the catalog number for full port.)

Meter Valve Options for 80 Series Coppersetters: Seal wire hole in inlet valve, seal wire hole in check valve

HEIGHT - 80 SERIES COPPERSETTERS ARE MADE TO "STANDARD" HEIGHTS

NOTE: Height dimensions are approximate.

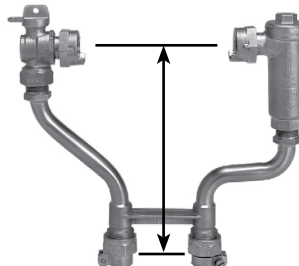

81 Series Coppersetter
for 5/8" Meter
and
82 Series Coppersetter
for 5/8"x3/4" Meter

Height is 7"
13/16" O.D. tubing

83 Series Coppersetter
for 3/4" Meter

Height is 9"
15/16" O.D. tubing

84 Series Coppersetter
for 1" Meter

Height is 10"
1-1/8" O.D. tubing

The Ford 80 Series Coppersetter

For 5/8", 5/8"x3/4", 3/4" or 1" Meter Size

Vertical Inlet and Outlet

STEP 2. INLET & OUTLET SERVICE LINE CONNECTIONS - (SECOND PART OF CATALOG NUMBER)

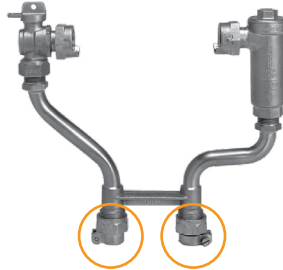

For 81 and 82 Series Coppersetters		
CATALOG NUMBER	DESCRIPTION	
	INLET CONNECTION	OUTLET CONNECTION
11-33-NL	3/4" Double Purpose Union Swivel Δ	3/4" Double Purpose Union Swivel Δ
12-33-NL	3/4" Double Purpose Union Swivel Δ	3/4" Flare Copper
▶ 14-33-NL	3/4" Double Purpose Union Swivel Δ	3/4" P.J. for Copper or Plastic Tubing (CTS)*
18-33-NL	3/4" Double Purpose Union Swivel Δ	3/4" Male Iron Pipe Union Swivel
21-33-NL	3/4" Flare Copper	3/4" Double Purpose Union Swivel Δ
± 22-33-NL	3/4" Flare Copper	3/4" Flare Copper
▶ 41-33-NL	3/4" P.J. for Copper or Plastic Tubing (CTS)*	3/4" Double Purpose Union Swivel Δ
▶♦ 44-33-NL	3/4" P.J. for Copper or Plastic Tubing (CTS)*	3/4" P.J. for Copper or Plastic Tubing (CTS)*
▶ 46-33-NL	3/4" P.J. for Copper or Plastic Tubing (CTS)*	3/4" P.J. for PE Pipe*
▶ 64-33-NL	3/4" P.J. for PE Pipe*	3/4" P.J. for Copper or Plastic Tubing (CTS)*
▶ 66-33-NL	3/4" P.J. for PE Pipe*	3/4" P.J. for PE Pipe*
77-33-NL	3/4" P.J. for PVC Pipe	3/4" P.J. for PVC Pipe
81-33-NL	3/4" Male Iron Pipe Union Swivel	3/4" Double Purpose Union Swivel Δ
88-33-NL	3/4" Male Iron Pipe Union Swivel	3/4" Male Iron Pipe Union Swivel
± FF-33-NL	3/4" Integral Female Iron Pipe	3/4" Integral Female Iron Pipe
44-34-NL	3/4" P.J. for Copper or Plastic Tubing (CTS)*	1" P.J. for Copper or Plastic Tubing (CTS)*
44-43-NL	1" P.J. for Copper or Plastic Tubing (CTS)*	3/4" P.J. for Copper or Plastic Tubing (CTS)*
11-44-NL	1" Double Purpose Union Swivel Δ	1" Double Purpose Union Swivel Δ
22-44-NL	1" Flare Copper	1" Flare Copper
▶ 44-44-NL	1" P.J. for Copper or Plastic Tubing (CTS)*	1" P.J. for Copper or Plastic Tubing (CTS)*

For 83 Series Coppersetters		
CATALOG NUMBER	DESCRIPTION	
	INLET CONNECTION	OUTLET CONNECTION
11-33-NL	3/4" Double Purpose Union Swivel Δ	3/4" Double Purpose Union Swivel Δ
18-33-NL	3/4" Double Purpose Union Swivel Δ	3/4" Male Iron Pipe Union Swivel
22-33-NL	3/4" Flare Copper	3/4" Flare Copper
▶♦ 44-33-NL	3/4" P.J. for Copper or Plastic Tubing (CTS)*	3/4" P.J. for Copper or Plastic Tubing (CTS)*
▶ 66-33-NL	3/4" P.J. for PE Pipe*	3/4" P.J. for PE Pipe*
81-33-NL	3/4" Male Iron Pipe Union Swivel	3/4" Double Purpose Union Swivel Δ
88-33-NL	3/4" Male Iron Pipe Union Swivel	3/4" Male Iron Pipe Union Swivel
11-44-NL	1" Double Purpose Union Swivel Δ	1" Double Purpose Union Swivel Δ
22-44-NL	1" Flare Copper	1" Flare Copper
▶ 44-44-NL	1" P.J. for Copper or Plastic Tubing (CTS)*	1" P.J. for Copper or Plastic Tubing (CTS)*

For 84 Series Coppersetters		
CATALOG NUMBER	DESCRIPTION	
	INLET CONNECTION	OUTLET CONNECTION
11-44-NL	1" Double Purpose Union Swivel Δ	1" Double Purpose Union Swivel Δ
12-44-NL	1" Double Purpose Union Swivel Δ	1" Flare Copper
21-44-NL	1" Flare Copper	1" Double Purpose Union Swivel Δ
22-44-NL	1" Flare Copper	1" Flare Copper
▶♦ 44-44-NL	1" P.J. for Copper or Plastic Tubing (CTS)*	1" P.J. for Copper or Plastic Tubing (CTS)*
▶ 66-44-NL	1" P.J. for PE Pipe*	1" P.J. for PE Pipe*
11-55-NL	1-1/4" Double Purpose Union Swivel Δ	1-1/4" Double Purpose Union Swivel Δ
22-55-NL	1-1/4" Flare Copper	1-1/4" Flare Copper
44-55-NL	1-1/4" P.J. for Copper or Plastic Tubing (CTS)*	1-1/4" P.J. for Copper or Plastic Tubing (CTS)*

* Grip Joint for CTS and PE pipe is available. Add "-G" to the catalog number.

♦ Quick Joint is available. Add "-Q" to the catalog number.

▶ Ultra-Tite is available. Contact factory for more information.

Δ Double Purpose Union Swivels will accommodate male iron pipe threads or flare copper.

± 81 and 82 Series Coppersetters with the indicated service line connections have a (vertical) brace eye. (Not available with Quick Joint or Ultra-Tite.)

Note: Ford Pack Joints for PVC are recommended for Schedule 40 and Schedule 80 pipe only.

The Ford 70-80 Series Angle Coppersetter

For 5/8", 5/8"x3/4", 3/4" or 1" Meter Size
Vertical Inlet and Horizontal Outlet

Standard service installation in some water utilities calls for tubing from the main to the curb meter setting to be relatively deep, and the pipe from the meter box to the house to be shallower. The Angle Coppersetter has a vertical inlet and horizontal outlet. It can be furnished with a variety of valves as described below.

To order: Select one catalog number from each of the two charts on pages 20 and 21 to arrive at the complete Coppersetter catalog number. Selection order of components:

- Step 1. Meter size and valve type page 20
- Step 2. Service line connections page 21

Example of Catalog Number for a 70-80 Series Coppersetter

FIRST PART OF NUMBER
(meter size and valve type)

SECOND PART OF NUMBER
(service line connection type and size)

VBHC72-82W-41-33-NL

Angle Ball Meter Valve on inlet

Cartridge Angle Dual Check on outlet

70-80 Series Coppersetter

For 5/8" x 3/4" meter only

Angle Meter Ball and Key Valves are **with** Padlock Wing
Compression valves are **without** Padlock Wing

"No-lead" brass*

3/4" Outlet Service Line Connection

3/4" Inlet Service Line Connection

Double Purpose Union Swivel Outlet Service Line Connection

Pack Joint for CTS Inlet Service Line Connection

Approximate height for 5/8", 5/8" x 3/4" and 3/4" meter is 7" and for 1" meter is 10"

The description for the above catalog number reads: 70-80 Series Coppersetter for 5/8" x 3/4" meter with an Angle Ball Meter Valve on the inlet, Cartridge Angle Dual Check on the outlet, with 3/4" Pack Joint for CTS inlet by 3/4" double purpose union swivel outlet.

* Ford Meter Box no-lead brass products manufactured from UNS/CDA No. 89833 alloy shall contain no more than 0.25% total lead content by weight. United States federal and state laws allow the use of products manufactured from UNS C83600 85-5-5-5 brass alloy for only non-potable water systems within the United States.

Catalog Numbering

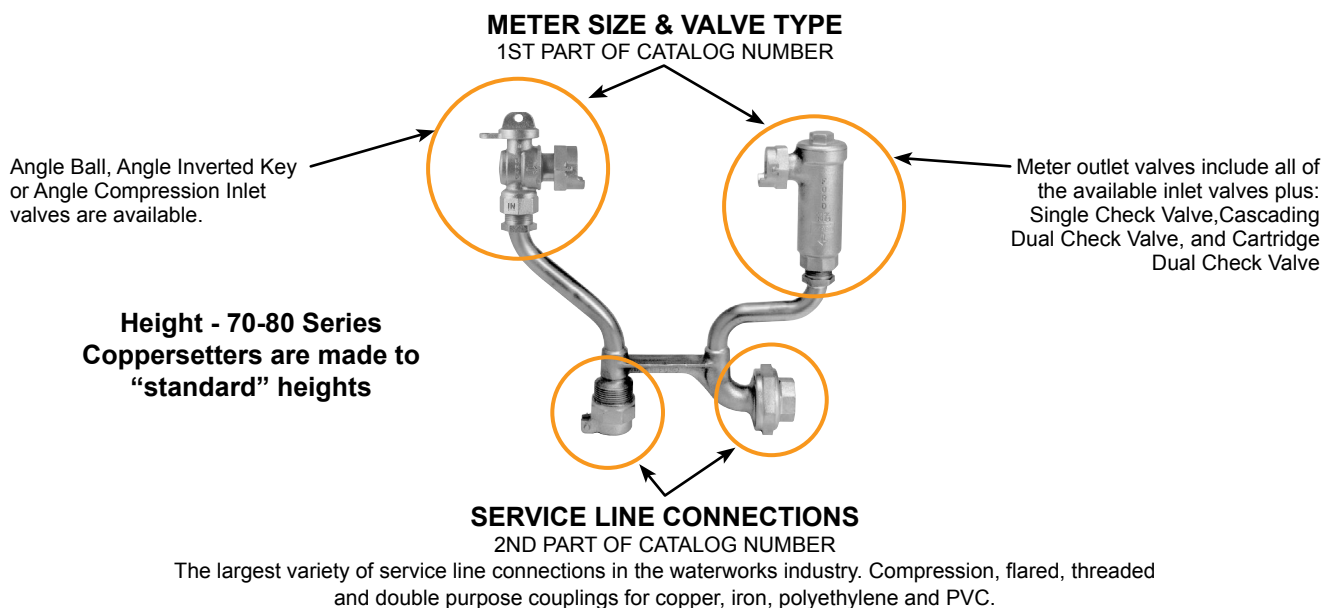

The Ford 70-80 Series Angle Coppersetter

For 5/8", 5/8"x3/4", 3/4" or 1" Meter Size

Vertical Inlet and Horizontal Outlet

STEP 1. METER SIZE & VALVE TYPE - (FIRST PART OF CATALOG NUMBER)

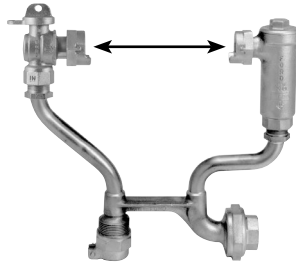

CATALOG NUMBER (METER SIZE AND VALVE TYPE)				DESCRIPTION	
FOR 5/8"	FOR 5/8"x3/4"	FOR 3/4"	FOR 1"	INLET VALVE	OUTLET VALVE
V71-81	V72-82	V73-83	V74-84	Key	None
VB71-81	VB72-82	VB73-83	VB74-84	Ball	None
VBB71-81***	VBB72-82***	VBB73-83	VBB74-84	Ball	Ball
VVG71-81*	VVG72-82*	VVG73-83*	VVG74-84*	Key	Compression
VV71-81	VV72-82	VV73-83	VV74-84	Key	Key
VH71-81	VH72-82	VH73-83	VH74-84	Key	Single Check
VHH71-81	VHH72-82	VHH73-83	VHH74-84 ▼	Key	Cascading Dual Check
VHC71-81**	VHC72-82**	VHC73-83**	VHC74-84**	Key	● Cartridge Dual Check
VBH71-81	VBH72-82	VBH73-83	VBH74-84	Ball	Single Check
VBHH71-81	VBHH72-82	VBHH73-83	VBHH74-84 ▼	Ball	Cascading Dual Check
VBHC71-81**	VBHC72-82**	VBHC73-83**	VBHC74-84**	Ball	● Cartridge Dual Check

* Compression valve does not have padlock wing.

** 70-80 Series Coppersettors with cartridge dual check valve have a 9" minimum height for 5/8", 5/8" x 3/4" meters, and a 12" minimum height for 3/4" and 1" meters.

*** The 5/8" port angle ball valve is a one-way directional valve designed for the inlet side of the meter and should not be used as a customer shut-off on the customer side of the meter.

▼ Angle Cascading Dual Check Valves contain 3/4" internal components. This valve meets the ASSE flow requirements of a 1" valve. For a full port valve, order the cartridge style check valve.

- Cartridges with enhanced chlorine/chloramine resistance are available. Add "CR" to end of alpha code. Example: VHC72-82-15W-44-33-NL

Note: Settors with angle ball valve will be reduced port unless otherwise requested. Reduced port valves usually provide suitable water flow. (Add "-FP" to the catalog number for full port.)

Meter Valve Options for 70-80 Series Coppersettors: Seal wire hole in inlet valve, seal wire hole in check valve

HEIGHT - 70-80 SERIES COPPERSETTERS ARE MADE TO "STANDARD" HEIGHTS

NOTE: Height dimensions are approximate.

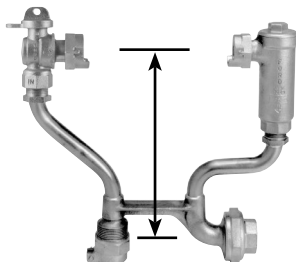

71-81 Series Coppersetter
for 5/8" Meter
and
72-82 Series Coppersetter
for 5/8"x3/4" Meter
Height is 7"
13/16" O.D. tubing

73-83 Series Coppersetter
for 3/4" Meter
Height is 7"
13/16" O.D. tubing

74-84 Series Coppersetter
for 1" Meter
Height is 10"
1-1/8" O.D. tubing

The Ford 70-80 Series Angle Coppersetter

For 5/8", 5/8"x3/4", 3/4" or 1" Meter Size
Vertical Inlet and Horizontal Outlet

STEP 2. INLET & OUTLET SERVICE LINE CONNECTIONS - (SECOND PART OF CATALOG NUMBER)

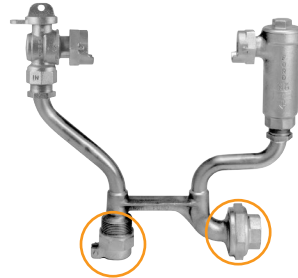

FOR 71-81, 72-82 AND 73-83 SERIES COPPERSETTERS		
CATALOG NUMBER	DESCRIPTION	
	INLET CONNECTION	OUTLET CONNECTION
11-33-NL	3/4" Double Purpose Union Swivel Δ	3/4" Double Purpose Union Swivel Δ
▶ 14-33-NL	3/4" Double Purpose Union Swivel Δ	3/4" P.J. for Copper or Plastic Tubing (CTS)*
18-33-NL	3/4" Double Purpose Union Swivel Δ	3/4" Male Iron Pipe Union Swivel
21-33-NL	3/4" Flare Copper	3/4" Double Purpose Union Swivel Δ
▶♦ 41-33-NL	3/4" P.J. for Copper or Plastic Tubing (CTS)*	3/4" Double Purpose Union Swivel Δ
▶ 44-33-NL	3/4" P.J. for Copper or Plastic Tubing (CTS)*	3/4" P.J. for Copper or Plastic Tubing (CTS)*
81-33-NL	3/4" Male Iron Pipe Union Swivel	3/4" Double Purpose Union Swivel Δ
88-33-NL	3/4" Male Iron Pipe Union Swivel	3/4" Male Iron Pipe Union Swivel
21-44-NL	1" Flare Copper	1" Double Purpose Union Swivel Δ
▶● 41-44-NL	1" P.J. for Copper or Plastic Tubing (CTS)*	1" Double Purpose Union Swivel Δ
● 66-44-NL	1" P.J. for PE Pipe*	1" P.J. for PE Pipe*

* Grip Joint for CTS (all sizes) and PE pipe is available. Add "-G" to the catalog number.

♦ Quick Joint is available. Add "-Q" to the catalog number.

▶ Ultra-Tite is available. Contact factory for more information.

Δ Double Purpose Union Swivels will accommodate male iron pipe threads or flare copper.

● These connections on 73-83 Series Coppersetters will have 13/16" O.D. copper tubing.

FOR 74-84 SERIES COPPERSETTERS		
CATALOG NUMBER	DESCRIPTION	
	INLET CONNECTION	OUTLET CONNECTION
11-44-NL	1" Double Purpose Union Swivel Δ	1" Double Purpose Union Swivel Δ
18-44-NL	1" Double Purpose Union Swivel Δ	1" Male Iron Pipe Union Swivel
21-44-NL	1" Flare Copper	1" Double Purpose Union Swivel Δ
28-44-NL	1" Flare Copper	1" Male Iron Pipe Union Swivel
▶♦ 41-44-NL	1" P.J. for Copper or Plastic Tubing (CTS)*	1" Double Purpose Union Swivel Δ
▶♦ 44-44-NL	1" P.J. for Copper or Plastic Tubing (CTS)*	1" P.J. for Copper or Plastic Tubing (CTS)*
▶♦ 48-44-NL	1" P.J. for Copper or Plastic Tubing (CTS)*	1" Male Iron Pipe Union Swivel
81-44-NL	1" Male Iron Pipe Union Swivel	1" Double Purpose Union Swivel Δ
88-44-NL	1" Male Iron Pipe Union Swivel	1" Male Iron Pipe Union Swivel

* Grip Joint for CTS and PE pipe is available. Add "-G" to the catalog number.

♦ Quick Joint is available. Add "-Q" to the catalog number.

▶ Ultra-Tite is available. Contact factory for more information.

Δ Double Purpose Union Swivels will accommodate male iron pipe threads or flare copper.

The Ford 90 Series Coppersetter

For 5/8", 5/8"x3/4", 3/4" or 1" Meter Size

Each conduit of the 90 Series Coppersetter is one piece of copper tubing and the two conduits are connected by a clamp. This flexible design provides adjustability to the space between service pipe ends during installation. The clamp is normally soldered permanently to the tubes but can be furnished with a bolted clamp so that the two conduits can be taken apart, if desired. An optional extended outlet leg provides customer side hook-up without disturbing the pit.

To order: Select one Catalog Number component from the charts on pages 23 through 25 to arrive at the complete Coppersetter Catalog Number. Selection order of components:

- Step 1. Meter size and valve type page 23
- Step 2. Coppersetter height page 23
- Step 3. Service line connections page 24-25
- Options: Outlet extension, bolted clamp construction and brace eye page 25

Example of Catalog Number for a 90 Series Coppersetter

FIRST PART OF NUMBER
(meter size and valve type)

SECOND PART OF NUMBER
(coppersetter height)

THIRD PART OF NUMBER
(service line connection type and size)

VBHC92-15W-44-33A-NL

- Angle Ball Meter Valve on inlet
- Cartridge Angle Dual Check on outlet
- 90 Series Coppersetter
- For 5/8"x3/4" meter only
- 15" Riser Height from Center Line of Service Line Connection to Center Line of Meter Spud

Angle Meter Ball and Key Valves are with Padlock Wing - Compression valves are without Padlock Wing

- "No-Lead" Brass*
- Optional Outlet Tube Extension A = 15" & B = 18"
- 3/4" Outlet Service Line Connection
- 3/4" Inlet Service Line Connection
- Pack Joint for CTS Outlet Service Line Connection
- Pack Joint for CTS Inlet Service Line Connection

The description for the above catalog number reads: 90 Series Coppersetter for 5/8"x3/4" meter, with an Angle Ball Meter Valve on the inlet and a Cartridge Angle Dual Check on the outlet, 15 inches high, with 3/4" Pack Joint for CTS inlet by 3/4" Pack Joint for CTS outlet on an optional 15" extended outlet tube.

* Ford Meter Box no-lead brass products manufactured from UNS/CDA No. 89833 alloy shall contain no more than 0.25% total lead content by weight. United States federal and state laws allow the use of products manufactured from UNS C83600 85-5-5-5 brass alloy for only non-potable water systems within the United States.

Catalog Numbering

METER SIZE & VALVE TYPE
1ST PART OF CATALOG NUMBER

Angle Ball, Angle Inverted Key or Angle Compression Inlet valves are available.

Meter outlet valves include all of the available inlet valves plus: Single Check Valve, Cascading Dual Check Valve, and Cartridge Dual Check Valve



Optional "BCL" bolted clamp construction

HEIGHT
2ND PART OF CATALOG NUMBER

Standard solder clamp construction

Optional outlet tube extension. Vertical inlet and inlet extensions are also available. See page 30.

SERVICE LINE CONNECTIONS
3RD PART OF CATALOG NUMBER

The largest variety of service line connections in the waterworks industry. Compression, flared, threaded and double purpose couplings for copper, iron, polyethylene and PVC.

The Ford 90 Series Coppersetter

For 5/8", 5/8"x3/4", 3/4" or 1" Meter Size

STEP 1. METER SIZE & VALVE TYPE - (FIRST PART OF CATALOG NUMBER)



CATALOG NUMBER (METER SIZE AND VALVE TYPE)				DESCRIPTION	
FOR 5/8"	FOR 5/8"x3/4"	FOR 3/4"	FOR 1"	INLET VALVE	OUTLET VALVE
91	92	93	94	None	None
V91	V92	V93	V94	Key	None
VB91	VB92	VB93	VB94	Ball	None
VBB91***	VBB92***	VBB93	VBB94	Ball	Ball
VVG91*	VVG92*	VVG93*	VVG94*	Key	Compression
VV91	VV92	VV93	VV94	Key	Key
VH91	VH92	VH93	VH94	Key	Single Check
VHH91	VHH92	VHH93	VHH94▼	Key	Cascading Dual Check
VHC91**	VHC92**	VHC93**	VHC94**	Key	● Cartridge Dual Check
VBH91	VBH92	VBH93	VBH94	Ball	Single Check
VBHH91	VBHH92	VBHH93	VBHH94▼	Ball	Cascading Dual Check
VBHC91**	VBHC92**	VBHC93**	VBHC94**	Ball	● Cartridge Dual Check

* Compression valve does not have padlock wing.

** 91 and 92 Series Coppersetters with cartridge dual check valves have a 12" minimum height. 93 Series Coppersetters with cartridge dual check valve have a 15" minimum height. 94 Series Coppersetters with cartridge dual check valve have an 18" minimum height.

*** The 5/8" port angle ball valve is a one-way directional valve designed for the inlet side of the meter and should not be used as a customer shut-off on the customer side of the meter.

▼ Angle cascading dual check valves contain 3/4" internal components. This valve meets the ASSE flow requirements of a 1" valve. For a full port valve, order the cartridge style check valve.

● Cartridges with enhanced chlorine/chloramine resistance are available. Add "CR" to end of alpha code. Example: VHC92-15W-44-33-NL

Note: Setters with angle ball valve will be reduced port unless otherwise requested. Reduced port valves usually provide suitable water flow. (Add "-FP" to the catalog number for full port.)

Meter Valve Options for 90 Series Coppersetters: Seal wire hole in inlet valve, seal wire hole in check valve

STEP 2. HEIGHT - (SECOND PART OF CATALOG NUMBER)

NOTE: Height dimensions are approximate.

For 5/8", 5/8"x3/4" and 3/4" Meter

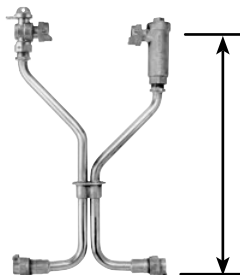

CATALOG NUMBER	HEIGHT IN INCHES
*9W	9
12W	12
15W	15
18W	18
21W	21
24W	24

* 9" height only available on 5/8" and 5/8"x3/4" 90 Series Coppersetters

For 1" Meter

CATALOG NUMBER	HEIGHT IN INCHES
15W	15
18W	18
21W	21
24W	24

HEIGHT INFORMATION FOR 90 SERIES COPPERSETTERS:

- Contact factory for availability of heights not listed.
- Coppersetters are available in heights over 24" in 3" increments; 27", 30", 33" etc. To order, put desired height in catalog number. Example: V92-33W-11-33-NL is a 33" high setter.
- 90 Series over 39" height will have two clamping bolts.

The Ford 90 Series Coppersetter

For 5/8", 5/8"x3/4" or 3/4" Meter Size

STEP 3. SERVICE LINE CONNECTION - (THIRD PART OF CATALOG NUMBER)



CATALOG NUMBER	Pack Joint Inlet by Pack Joint Outlet	
	INLET CONNECTION	OUTLET CONNECTION
▶♦ 44-33-NL	3/4" P.J. for Copper or Plastic Tubing (CTS)*	3/4" P.J. for Copper or Plastic Tubing (CTS)*
▶ 46-33-NL	3/4" P.J. for Copper or Plastic Tubing (CTS)*	3/4" P.J. for PE Pipe*
▶ 47-33-NL	3/4" P.J. for Copper or Plastic Tubing (CTS)	3/4" P.J. for PVC Pipe
▶ 64-33-NL	3/4" P.J. for PE Pipe*	3/4" P.J. for Copper or Plastic Tubing (CTS)*
▶ 66-33-NL	3/4" P.J. for PE Pipe*	3/4" P.J. for PE Pipe*
▶ 74-33-NL	3/4" P.J. for PVC Pipe	3/4" P.J. for Copper or Plastic Tubing (CTS)*
▶ 77-33-NL	3/4" P.J. for PVC Pipe	3/4" P.J. for PVC Pipe
▶● 47-34-NL	3/4" P.J. for Copper or Plastic Tubing (CTS)	1" P.J. for PVC Pipe
▶♦♦ 44-44-NL	1" P.J. for Copper or Plastic Tubing (CTS)*	1" P.J. for Copper or Plastic Tubing (CTS)*
▶● 47-44-NL	1" P.J. for Copper or Plastic Tubing (CTS)*	1" P.J. for PVC Pipe
▶● 66-44-NL	1" P.J. or PE Pipe*	1" P.J. for PE Pipe*
▶● 67-44-NL	1" P.J. for PE Pipe*	1" P.J. for PVC Pipe
▶● 74-44-NL	1" P.J. for PVC Pipe	1" P.J. for Copper or Plastic Tubing (CTS)*
▶● 76-44-NL	1" P.J. for PVC Pipe	1" P.J. or PE Pipe*
● 77-44-NL	1" P.J. for PVC Pipe	1" P.J. for PVC Pipe

CATALOG NUMBER	Pack Joint Inlet by Iron Pipe Outlet	
	INLET CONNECTION	OUTLET CONNECTION
▶♦ 14-33-NL	3/4" Double Purpose Union Swivel Δ	3/4" P.J. for Copper or Plastic Tubing (CTS)*
▶ 16-33-NL	3/4" Double Purpose Union Swivel Δ	3/4" P.J. for PE Pipe*
▶ 17-33-NL	3/4" Double Purpose Union Swivel Δ	3/4" P.J. for PVC Pipe
▶♦ 41-33-NL	3/4" P.J. for Copper or Plastic Tubing (CTS)*	3/4" Double Purpose Union Swivel Δ
▶♦ 48-33-NL	3/4" P.J. for Copper or Plastic Tubing (CTS)*	3/4" Male Iron Pipe Union Swivel
▶ 61-33-NL	3/4" P.J. for PE Pipe*	3/4" Double Purpose Union Swivel Δ
▶ 68-33-NL	3/4" P.J. for PE Pipe*	3/4" Male Iron Pipe Union Swivel
▶ 71-33-NL	3/4" P.J. for PVC Pipe	3/4" Double Purpose Union Swivel Δ
▶ 78-33-NL	3/4" P.J. for PVC Pipe	3/4" Male Iron Pipe Union Swivel
▶♦ 84-33-NL	3/4" Male Iron Pipe Union Swivel	3/4" P.J. for Copper or Plastic Tubing (CTS)*
▶ 86-33-NL	3/4" Male Iron Pipe Union Swivel	3/4" P.J. for PE Pipe*
▶ 87-33-NL	3/4" Male Iron Pipe Union Swivel	3/4" P.J. for PVC Pipe
▶ 41-43-NL	1" P.J. for Copper or Plastic Tubing (CTS)*	3/4" Double Purpose Union Swivel Δ
▶♦♦ 14-44-NL	1" Double Purpose Union Swivel Δ	1" P.J. for Copper or Plastic Tubing (CTS)*
▶● 16-44-NL	1" Double Purpose Union Swivel Δ	1" P.J. for PE Pipe*
● 17-44-NL	1" Double Purpose Union Swivel Δ	1" P.J. for PVC Pipe
▶♦♦ 41-44-NL	1" P.J. for Copper or Plastic Tubing (CTS)*	1" Double Purpose Union Swivel Δ
▶ 48-44-NL	1" P.J. for Copper or Plastic Tubing (CTS)*	1" Male Iron Pipe Union Swivel
▶● 61-44-NL	1" P.J. for PE Pipe*	1" Double Purpose Union Swivel Δ
▶● 68-44-NL	1" P.J. for PE Pipe*	1" Male Iron Pipe Union Swivel
● 71-44-NL	1" P.J. for PVC Pipe	1" Double Purpose Union Swivel Δ
● 78-44-NL	1" P.J. for PVC Pipe	1" Male Iron Pipe Union Swivel
▶ 84-44-NL	1" Male Iron Pipe Union Swivel	1" P.J. for Copper or Plastic Tubing (CTS)*
▶● 86-44-NL	1" Male Iron Pipe Union Swivel	1" P.J. for PE Pipe*
● 87-44-NL	1" Male Iron Pipe Union Swivel	1" P.J. for PVC Pipe

CATALOG NUMBER	Iron Pipe and Flare Copper Connections	
	INLET CONNECTION	OUTLET CONNECTION
11-33-NL	3/4" Double Purpose Union Swivel Δ	3/4" Double Purpose Union Swivel Δ
12-33-NL	3/4" Double Purpose Union Swivel Δ	3/4" Flare Copper
18-33-NL	3/4" Double Purpose Union Swivel Δ	3/4" Male Iron Pipe Union Swivel
21-33-NL	3/4" Flare Copper	3/4" Double Purpose Union Swivel Δ
22-33-NL	3/4" Flare Copper	3/4" Flare Copper
28-33-NL	3/4" Flare Copper	3/4" Male Iron Pipe Union Swivel
81-33-NL	3/4" Male Iron Pipe Union Swivel	3/4" Double Purpose Union Swivel Δ
82-33-NL	3/4" Male Iron Pipe Union Swivel	3/4" Flare Copper
88-33-NL	3/4" Male Iron Pipe Union Swivel	3/4" Male Iron Pipe Union Swivel
MM-33-NL	3/4" Integral Male Iron Pipe	3/4" Integral Male Iron Pipe
● 11-44-NL	1" Double Purpose Union Swivel Δ	1" Double Purpose Union Swivel Δ
● 22-44-NL	1" Flare Copper	1" Flare Copper

* Grip Joint for CTS and PE pipe is available. Add "-G" to the catalog number.

♦ Quick Joint is available. Add "-Q" to the catalog number.

▶ Ultra-Tite is available. Contact factory for more information.

Δ Double Purpose Union Swivels will accommodate male iron pipe threads or flare copper.

● These connections on 93 Series Coppersetters will have 13/16" O.D. copper tubing.

NOTE: Ford Pack Joints for PVC are recommended for Schedule 40 and Schedule 80 pipe only.

The Ford 90 Series Coppersetter

For 1" Meter Size

STEP 3. SERVICE LINE CONNECTION - (THIRD PART OF CATALOG NUMBER)



1" Pack Joint Both Ends		
CATALOG NUMBER	DESCRIPTION	
	INLET CONNECTION	OUTLET CONNECTION
▶♦ 44-44-NL	1" P.J. for Copper or Plastic Tubing (CTS)*	1" P.J. for Copper or Plastic Tubing (CTS)*
▶♦ 46-44-NL	1" P.J. for Copper or Plastic Tubing (CTS)*	1" P.J. for PE Pipe*
▶♦ 47-44-NL	1" P.J. for Copper or Plastic Tubing (CTS)	1" P.J. for PVC Pipe
▶♦ 64-44-NL	1" P.J. for PE Pipe	1" P.J. for Copper or Plastic Tubing (CTS)*
▶ 66-44-NL	1" P.J. for PE Pipe*	1" P.J. for PE Pipe*
▶♦ 74-44-NL	1" P.J. for PVC Pipe	1" P.J. for Copper or Plastic Tubing (CTS)
77-44-NL	1" P.J. for PVC Pipe	1" P.J. for PVC Pipe

1" Pack Joint One End		
CATALOG NUMBER	DESCRIPTION	
	INLET CONNECTION	OUTLET CONNECTION
▶♦ 14-44-NL	1" Double Purpose Union Swivel Δ	1" P.J. for Copper or Plastic Tubing (CTS)*
▶ 16-44-NL	1" Double Purpose Union Swivel Δ	1" P.J. for PE Pipe*
▶♦ 41-44-NL	1" P.J. for Copper or Plastic Tubing (CTS)*	1" Double Purpose Union Swivel Δ
▶♦ 48-44-NL	1" P.J. for Copper or Plastic Tubing (CTS)*	1" Male Iron Pipe Union Swivel
▶ 61-44-NL	1" P.J. for PE Pipe*	1" Double Purpose Union Swivel Δ
4M-44-NL	1" P.J. for Copper or Plastic Tubing (CTS)*	1" Integral Male Iron Pipe

Iron Pipe and Flare Connections		
CATALOG NUMBER	DESCRIPTION	
	INLET CONNECTION	OUTLET CONNECTION
11-44-NL	1" Double Purpose Union Swivel Δ	1" Double Purpose Union Swivel Δ
12-44-NL	1" Double Purpose Union Swivel Δ	1" Flare Copper
18-44-NL	1" Double Purpose Union Swivel Δ	1" Male Iron Pipe Union Swivel
21-44-NL	1" Flare Copper	1" Double Purpose Union Swivel Δ
22-44-NL	1" Flare Copper	1" Flare Copper
28-44-NL	1" Flare Copper	1" Male Iron Pipe Union Swivel
82-44-NL	1" Male Iron Pipe Union Swivel	1" Flare Copper
88-44-NL	1" Male Iron Pipe Union Swivel	1" Male Iron Pipe Union Swivel
81-44-NL	1" Male Iron Pipe Union Swivel	1" Double Purpose Union Swivel Δ
MM-44-NL	1" Integral Male Iron Pipe	1" Integral Male Iron Pipe

Δ Double Purpose Union Swivels will accommodate male iron pipe threads or flare copper.

* **Grip Joint** for CTS and PE pipe is available. Add "-G" to the catalog number.

♦ **Quick Joint** is available. Add "-Q" to the catalog number.

▶ **Ultra-Tite** is available. Contact factory for more information.

NOTE: Ford Pack Joints for PVC are recommended for Schedule 40 and Schedule 80 pipe only.

Example: For vertical inlet, place a "Z" before any of the listed option codes.

Example: "ZA" is a vertical inlet and a 15" outlet tube extension.

Note: Brace eye is not available with vertical inlet.

OPTIONS FOR 90 SERIES COPPERSETTERS	EXTENSION TO CATALOG NUMBER
Brace Eye	Add "E" to Cat. No.
Bolted clamp construction	Add "C" to Cat. No.
15" inlet tube extension	Add "P" to Cat. No.
15" inlet tube extension & brace eye	Add "PE" to Cat. No.
15" inlet tube extension & bolted clamp	Add "PC" to Cat. No.
15" outlet tube extension	Add "A" to Cat. No.
15" outlet tube extension & brace eye	Add "H" to Cat. No.
15" outlet tube extension & bolted clamp	Add "F" to Cat. No.
15" inlet and outlet tube extensions	Add "PA" to Cat. No.
15" inlet and outlet tube extensions & brace eye	Add "PH" to Cat. No.
15" inlet and outlet tube extensions & bolted clamp	Add "PF" to Cat. No.
18" inlet tube extension	Add "S" to Cat. No.
18" inlet tube extension & brace eye	Add "SE" to Cat. No.
18" inlet tube extension & bolted clamp	Add "SC" to Cat. No.
18" outlet tube extension	Add "B" to Cat. No.
18" outlet tube extension & brace eye	Add "K" to Cat. No.
18" outlet tube extension & bolted clamp	Add "J" to Cat. No.
18" inlet and outlet tube extensions	Add "SB" to Cat. No.
18" inlet and outlet tube extensions & brace eye	Add "SK" to Cat. No.
18" inlet and outlet tube extensions & bolted clamp	Add "SJ" to Cat. No.
Vertical Inlet	Add "Z" to Cat. No.

Ford Tandem Copper setters

Designed to solve problems resulting from excessive water pressure, the Tandem Copper setter holds a pressure regulator just ahead of the water meter – all in one compact, quickly-installed Ford Copper setter device. Pressure of the water flow through the meter and customer service lines is thereby easily reduced.

This space-saving unit is designed for installation in a single meter pit, frequently as small as 20" in diameter. Ford recommends service lines and valves be set at a minimum of 2" from the pit wall to help prevent freezing.

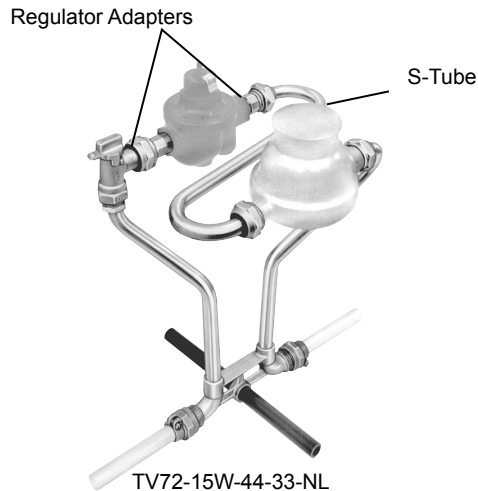

HOW TO ORDER

Select Copper setter Series desired. Add the letter "T" before Catalog Number selected. EXAMPLE: TV72-18W-21-33-NL = Tandem Copper setter for 5/8" x 3/4" meter, 18" high with 3/4" flared copper inlet and with double purpose union swivel outlet. Tandem Copper setters include an "S" tube and male iron pipe adapters for holding a pressure regulator. Unless specified otherwise, standard Tandem Copper setters are designed to hold a water meter in series with a pressure regulator.

PRV Lengths and Spacing for Standard Tandem Copper setters and Resetters

PRV side of Tandem Standard Setter			
METER SIZE	STANDARD SPACING	FNPT PRV LENGTH TO USE WITH STANDARD ADAPTERS	STANDARD ADAPTER
5/8"	7-1/2"	4-3/4"	RA-1-NL
5/8" x 3/4"	7-1/2"	4-3/8"	RA-2-NL
3/4"	9"	5-7/8"	RA-2-NL
1"	9"	5-19/32"	RA-4-NL

5/8" - 1" Tandem Setters built for standard length PRV's with FNPT end-connections **include regulator adapters and "S" tube**. For PRV lengths with end connections other than FNPT or lengths other than what is listed in the above table, contact factory for price and availability.

If ordering non-standard PRV spacing, add PRV length to the catalog number.

Examples: TVBH72-15W-11-33-6-5-NL (6-1/2" PRV spacing) TVBH74-18W-44-44-LRA-9-5-NL (9-1/2" PRV spacing without adapters)

Minimum Height on Tandem Copper setters and Resetters with Cartridge Dual Check Valve		
Tandem Copper setter or Resetter	Meter Size	*Minimum Height
70, 270, 80, 70-80 Series Copper setters or 40 Series Resetters	5/8", 5/8" x 3/4"	9"
	3/4"	15"
	1"	15"
90 Series Copper setter or 30 Series Resetter	5/8", 5/8" x 3/4"	15"
	3/4"	15"
	1"	18"

* For actual height contact factory.

Adapters for Regulator (sold as pairs) (male meter thread x MNPT)



CATALOG NUMBER	METER SIZE	ADAPTER LENGTH	APPROX. WT. LBS.
RA-1-NL	5/8"	1-7/8"	0.5
RA-2-NL	5/8"x3/4"	2-1/16"	0.7
RA-4-NL	1"	2-1/4"	1.2

"S" Tube with Meter Swivel Nuts (including gaskets)

CATALOG NUMBER	METER SIZE	APPROX. WT. LBS.
ST-1	5/8"	1.3
ST-2	5/8" x 3/4"	1.4
ST-3	3/4"	1.8
ST-4	1"	2.5

Ford Linesetters

The Ford Linesetter is an economical way to support the meter and speed meter changeouts in areas where shallow service line depths are possible. The short rise provided by the Linesetter helps keep the meter out of the dirt at the bottom of the meter box, and the setter assembly supports the service line. Cut-in style Linesetters can be used when installing meters in previously unmetred services, and eliminate the need to flare or thread old service lines.



LSV11-233W-NL

The LSV11-233W-NL is an example of a Linesetter for a 5/8" x 3/4" meter. Service line connections are double purpose. Brace eyes optional.



LSV44-444W-NL

The LSV44-444W-NL is an example of a Linesetter for a 1" meter. Service line connections are Pack Joint for CTS. Brace eyes are standard on all Linesetters for 1" meters.



LSAV21-233W-NL

The LSAV21-233W-NL is an example of a Angle Inlet Linesetter for a 5/8" x 3/4" meter. Service line connections are an angled flare copper inlet by double purpose outlet. Contact factory for optional brace eye.

Linesetters for 5/8" meters

3/4" DOUBLE PURPOSE INLET BY 3/4" DOUBLE PURPOSE OUTLET

CATALOG NUMBER FOR 5/8" METER	INLET VALVE TYPE	OUTLET VALVE TYPE
LS11-133-NL	None	None
LSV11-133W-NL	Key	None
LSVH11-133W-NL	Key	Single Check
LSVHH11-133W-NL	Key	Dual Check
LSVB11-133W-NL	Ball	None
LSVBH11-133W-NL	Ball	Single Check
LSVBHH11-133W-NL	Ball	Dual Check



3/4" DOUBLE PURPOSE INLET BY 3/4" MALE IRON PIPE OUTLET

CATALOG NUMBER FOR 5/8" METER	INLET VALVE TYPE	OUTLET VALVE TYPE
LS18-133-NL	None	None
LSV18-133W-NL	Key	None
LSVH18-133W-NL	Key	Single Check
LSVHH18-133W-NL	Key	Dual Check
LSVB18-133W-NL	Ball	None
LSVBH18-133W-NL	Ball	Single Check
LSVBHH18-133W-NL	Ball	Dual Check



3/4" PACK JOINT FOR CTS* INLET BY 3/4" DOUBLE PURPOSE OUTLET

CATALOG NUMBER FOR 5/8" METER	INLET VALVE TYPE	OUTLET VALVE TYPE
▶♦ LSV41-133W-NL	Key	None
▶♦ LSVH41-133W-NL	Key	Single Check
▶♦ LSVHH41-133W-NL	Key	Dual Check
▶♦ LSVB41-133W-NL	Ball	None
▶♦ LSVBH41-133W-NL	Ball	Single Check
▶♦ LSVBHH41-133W-NL	Ball	Dual Check



* Grip Joint for CTS is available. Add "-G" to the catalog number. Example: LSV41-133W-G-NL

♦ Quick Joint is available. Add "-Q" to the catalog number. Example: LSV41-133W-Q-NL

▶ Ultra-Tite is available. Contact factory for more information.

Note: 5/8" x 3/4", 3/4" and 1" Linesetter with angle ball valve will be reduced port unless otherwise specified. Reduced port valves usually provide suitable water flow. Add "-FP" to the catalog number for full port.

Note: To order Linesetter with brace eyes, add "1" to the part number. Example: LSV141-133W-NL.

Ford Linesetters

Linesetters for 5/8" x 3/4" meters



3/4" DOUBLE PURPOSE INLET BY 3/4" DOUBLE PURPOSE OUTLET

CATALOG NUMBER FOR 5/8"x3/4" METER	INLET VALVE TYPE	OUTLET VALVE TYPE
LS11-233-NL	None	None
LSV11-233W-NL	Key	None
LSVH11-233W-NL	Key	Single Check
LSVHH11-233W-NL	Key	Dual Check
LSVB11-233W-NL	Ball	None
LSVBH11-233W-NL	Ball	Single Check
LSVBHH11-233W-NL	Ball	Dual Check



3/4" PACK JOINT FOR CTS* INLET BY 3/4" DOUBLE PURPOSE OUTLET

CATALOG NUMBER FOR 5/8"x3/4" METER	INLET VALVE TYPE	OUTLET VALVE TYPE
▶♦ LSV41-233W-NL	Key	None
▶♦ LSVH41-233W-NL	Key	Single Check
▶♦ LSVHH41-233W-NL	Key	Dual Check
▶♦ LSVB41-233W-NL	Ball	None
▶♦ LSVBH41-233W-NL	Ball	Single Check
▶♦ LSVBHH41-233W-NL	Ball	Dual Check



3/4" FLARE COPPER INLET BY 3/4" DOUBLE PURPOSE OUTLET

CATALOG NUMBER FOR 5/8"x3/4" METER	INLET VALVE TYPE	OUTLET VALVE TYPE
LSV21-233W-NL	Key	None
LSVH21-233W-NL	Key	Single Check
LSVHH21-233W-NL	Key	Dual Check
LSVB21-233W-NL	Ball	None
LSVBH21-233W-NL	Ball	Single Check
LSVBHH21-233W-NL	Ball	Dual Check



3/4" PACK JOINT FOR CTS* INLET BY 3/4" PACK JOINT FOR CTS* OUTLET

CATALOG NUMBER FOR 5/8"x3/4" METER	INLET VALVE TYPE	OUTLET VALVE TYPE
▶♦ LSV44-233W-NL	Key	None
▶♦ LSVH44-233W-NL	Key	Single Check
▶♦ LSVHH44-233W-NL	Key	Dual Check
▶♦ LSVB44-233W-NL	Ball	None
▶♦ LSVBH44-233W-NL	Ball	Single Check
▶♦ LSVBHH44-233W-NL	Ball	Dual Check

* **Grip Joint** for CTS is available. Add "-G" to the catalog number. Example: LSV44-233W-G-NL

♦ **Quick Joint** is available. Add "-Q" to the catalog number. Example: LSV44-233W-Q-NL

▶ **Ultra-Tite** is available. Contact factory for more information.

Note: 5/8" x 3/4", 3/4" and 1" Linesetter with angle ball valve will be reduced port unless otherwise specified. Reduced port valves usually provide suitable water flow. Add "-FP" to the catalog number for full port.

Note: To order Linesetter with brace eyes, add "1" to the part number. Example: LSVH121-233W-NL.

Ford Linesetters

Linesetters for 5/8" x 3/4" meters

3/4" ANGLED FLARE COPPER INLET BY 3/4" DOUBLE PURPOSE OUTLET



CATALOG NUMBER FOR 5/8"x3/4" METER	INLET VALVE TYPE	OUTLET VALVE TYPE
LSAV21-233W-NL	Key	None
LSAVH21-233W-NL	Key	Single Check
LSAVHH21-233W-NL	Key	Dual Check
LSAVB21-233W-NL	Ball	None
LSAVBH21-233W-NL	Ball	Single Check
LSAVBHH21-233W-NL	Ball	Dual Check

3/4" ANGLED PACK JOINT FOR CTS* INLET BY 3/4" DOUBLE PURPOSE OUTLET



CATALOG NUMBER FOR 5/8"x3/4" METER	INLET VALVE TYPE	OUTLET VALVE TYPE
LSAV41-233W-NL	Key	None
LSAVH41-233W-NL	Key	Single Check
LSAVHH41-233W-NL	Key	Dual Check
LSAVB41-233W-NL	Ball	None
LSAVBH41-233W-NL	Ball	Single Check
LSAVBHH41-233W-NL	Ball	Dual Check

* **Grip Joint** for CTS is available. Add "-G" to the catalog number. Example: LSAV41-233W-G-NL

Linesetters for 3/4" meters

3/4" DOUBLE PURPOSE INLET BY 3/4" DOUBLE PURPOSE OUTLET



CATALOG NUMBER FOR 3/4" METER	INLET VALVE TYPE	OUTLET VALVE TYPE
LS11-333-NL	None	None
LSV11-333W-NL	Key	None
LSVH11-333W-NL	Key	Single Check
LSVHH11-333W-NL	Key	Dual Check
LSVB11-333W-NL	Ball	None
LSVBH11-333W-NL	Ball	Single Check
LSVBHH11-333W-NL	Ball	Dual Check

OTHER 3/4" LINESETTERS

Besides the 3/4" linesetters listed in this table, any of the 5/8"x3/4" linesetter listings are available as 3/4" linesetters by changing the catalog number. Example: an LSV44-233W-NL for 5/8"x3/4" meter will read LSV44-333W-NL for 3/4" meter.

Note: 5/8" x 3/4", 3/4" and 1" Linesetter with angle ball valve will be reduced port unless otherwise specified. Reduced port valves usually provide suitable water flow. Add "-FP" to the catalog number for full port.

Note: To order Linesetter with brace eyes, add "1" to the part number. Example: LSVB111-333W-NL.

Ford Linesetters

Linesetters for 1" meters



1" DOUBLE PURPOSE INLET BY 1" DOUBLE PURPOSE OUTLET

CATALOG NUMBER FOR 1" METER	INLET VALVE TYPE	OUTLET VALVE TYPE
LSV11-444W-NL	Key	None
LSVH11-444W-NL	Key	Single Check
LSVHH11-444W-NL	Key	Dual Check ▼
LSVB11-444W-NL	Ball	None
LSVBH11-444W-NL	Ball	Single Check
LSVBHH11-444W-NL	Ball	Dual Check ▼



1" FLARE COPPER INLET BY 1" DOUBLE PURPOSE OUTLET

CATALOG NUMBER FOR 1" METER	INLET VALVE TYPE	OUTLET VALVE TYPE
LSV21-444W-NL	Key	None
LSVH21-444W-NL	Key	Single Check
LSVHH21-444W-NL	Key	Dual Check ▼
LSVB21-444W-NL	Ball	None
LSVBH21-444W-NL	Ball	Single Check
LSVBHH21-444W-NL	Ball	Dual Check ▼



1" PACK JOINT FOR CTS* INLET BY 1" DOUBLE PURPOSE OUTLET

CATALOG NUMBER FOR 1" METER	INLET VALVE TYPE	OUTLET VALVE TYPE
▶◆ LSV41-444W-NL	Key	None
▶◆ LSVH41-444W-NL	Key	Single Check
▶◆ LSVHH41-444W-NL	Key	Dual Check ▼
▶◆ LSVB41-444W-NL	Ball	None
▶◆ LSVBH41-444W-NL	Ball	Single Check
▶◆ LSVBHH41-444W-NL	Ball	Dual Check ▼

* Grip Joint for CTS is available. Add "-G" to the catalog number. Example: LSV41-444W-G-NL.

◆ Quick Joint is available. Add "-Q" to the catalog number. Example: LSV41-444W-Q-NL.



1" PACK JOINT FOR CTS* INLET BY 1" PACK JOINT FOR CTS* OUTLET

CATALOG NUMBER FOR 1" METER	INLET VALVE TYPE	OUTLET VALVE TYPE
▶◆ LSV44-444W-NL	Key	None
▶◆ LSVH44-444W-NL	Key	Single Check
▶◆ LSVHH44-444W-NL	Key	Dual Check ▼
▶◆ LSVB44-444W-NL	Ball	None
▶◆ LSVBH44-444W-NL	Ball	Single Check
▶◆ LSVBHH44-444W-NL	Ball	Dual Check ▼

* Grip Joint for CTS is available. Add "-G" to the catalog number. Example: LSV44-444W-G-NL.

◆ Quick Joint is available. Add "-Q" to the catalog number. Example: LSV44-444W-Q-NL.

▶ Ultra-Tite is available. Contact factory for more information.

▼ 1" Angle Cascading Dual Check Valves contain 3/4" internal components.

Note: 5/8" x 3/4", 3/4" and 1" Linesetter with angle ball valve will be reduced port unless otherwise specified. Reduced port valves usually provide suitable water flow. Add "-FP" to the catalog number for full port.

Ford Linesetters

Linesetters for 1" meters



1" Male Iron Pipe Inlet By 1" Double Purpose Outlet

CATALOG NUMBER FOR 1" METER	INLET VALVE TYPE	OUTLET VALVE TYPE
LSV81-444W-NL	Key	None
LSVH81-444W-NL	Key	Single Check
LSVHH81-444W-NL	Key	Dual Check ▼
LSVB81-444W-NL	Ball	None
LSVBH81-444W-NL	Ball	Single Check
LSVBHH81-444W-NL	Ball	Dual Check ▼

▼ 1" Angle cascading dual check valves contain 3/4" internal components.

Ford Pack Joint Linesetters - Cut-In Type

Order Pack Joint Assemblies Separately



CATALOG NUMBER	METER SIZE	INLET CONNECTION	OUTLET CONNECTION
WITHOUT VALVE			
LS00-100-NL	5/8"	Optional Pack Joint	Optional Pack Joint
LS00-200-NL	5/8"x3/4"	Optional Pack Joint	Optional Pack Joint
LS00-300-NL	3/4"	Optional Pack Joint	Optional Pack Joint
WITH VALVE			
LSV00-100W-NL	5/8"	Optional Pack Joint	Optional Pack Joint
LSV00-200W-NL	5/8"x3/4"	Optional Pack Joint	Optional Pack Joint
LSV00-300W-NL	3/4"	Optional Pack Joint	Optional Pack Joint

Pack Joint Assemblies for Cut-In Pack Joint Linesetters (two required per Linesetter)
see table on page 15 under 270 Series Coppersetters.

Options for Ford Linesetters

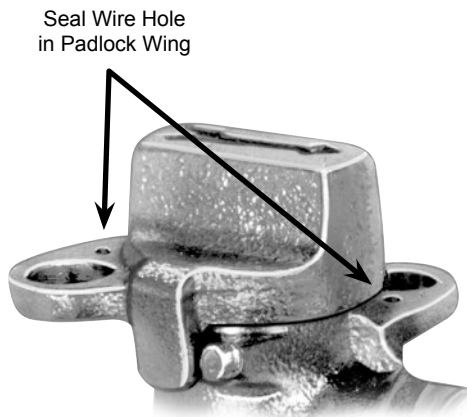

ADDITIONAL OPTIONS FOR LINESETTERS

Seal wire hole in inlet valve. To order add "- SEAL" to catalog number.
Example: LSV11-133W- SEAL-NL

Coppersetters for 1-1/2" & 2" Flanged Meters

Information for 1-1/2" & 2" Coppersetters

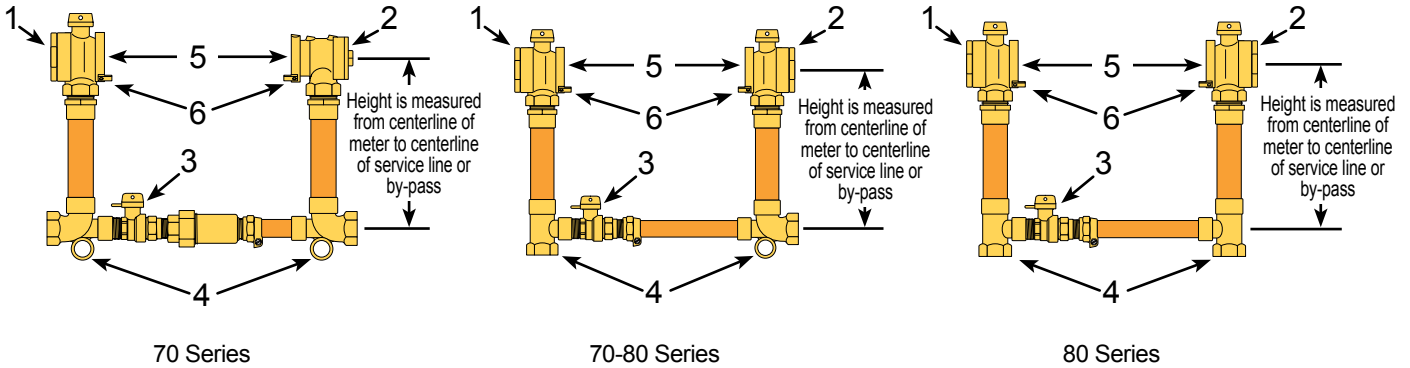

Specifications:

Ford Coppersetters are constructed from UNS/CDA No. C89833 no lead brass alloy (AWWA specification C800) and copper tubing. All Ford 1-1/2" and 2" Coppersetters are individually factory tested for water-tightness before shipment.

Individualized setting requirements can be satisfied using special Ford Coppersetters. We welcome the opportunity to solve your 1-1/2" and 2" setting problems.

1. Inlet valve options are a flanged angle inverted key or flanged angle ball valve.
2. All inlet valve options are also available on outlet* (see note below) - A flanged angle check outlet valve or a flanged angle dual check valve is available.
3. By-pass includes a Ford Ball Valve with padlock wings. An optional dual check valve in the by-pass is available. A high by-pass is also available. See photo below.
4. Brace pipe eyelets are standard on 70 and 70-80 Series - brace pipe not included.
5. Different meter flange spacing may be specified. Standard spacing for 1-1/2" meter setters is 13" and 17" for 2" meters.
6. All 1-1/2" and 2" meter flange valves on Coppersetters have meter support brackets.

* **NOTE:** 1-1/2" and 2" outlet ball valves may be used as customer shut-offs (on the customer side of the meter). The flange inverted key angle valves should **not** be used as customer shut-off on the customer side of the meter.

NOTE: 1-1/2" and 2" Tandem Coppersetters are available, add "T" to the beginning of the catalog number. Minimum rise of Tandem Coppersetter is 18". Contact factory with meter and PRV information.

HIGH BY-PASS OPTION

A high by-pass option is available on 1-1/2" and 2" Ford Coppersetters with a 12" minimum height.

To order: add "HB" to catalog number. Example: VV77-18HB-11-77-NL



70 Series Coppersetters for 1-1/2" & 2" Flanged Meters

Horizontal Inlet and Outlet

Unless otherwise specified - Standard meter spacing for: 1-1/2" Coppersetters = 13"
2" Coppersetters = 17"

KEY VALVE INLET AND METER ELL OUTLET

HEIGHT	SERVICE LINE CONNECTION		FOR 1-1/2" METER CATALOG NUMBER	APPROX. WT. LBS.	FOR 2" METER CATALOG NUMBER	APPROX. WT. LBS.
	INLET	OUTLET				
12"	FIP	FIP	V76-12-11-66-NL	20.3	V77-12-11-77-NL	27.0
	CTS*	FIP	V76-12-41-66-NL	22.0	V77-12-41-77-NL	28.0
	CTS*	CTS*	V76-12-44-66-NL	21.8	V77-12-44-77-NL	28.7
15"	FIP	FIP	V76-15-11-66-NL	22.0	V77-15-11-77-NL	28.0
	CTS*	FIP	V76-15-41-66-NL	24.0	V77-15-41-77-NL	29.0
	CTS*	CTS*	V76-15-44-66-NL	24.0	V77-15-44-77-NL	30.0
18"	FIP	FIP	V76-18-11-66-NL	24.0	V77-18-11-77-NL	30.0
	CTS*	FIP	V76-18-41-66-NL	24.0	V77-18-41-77-NL	31.0
	CTS*	CTS*	V76-18-44-66-NL	24.0	V77-18-44-77-NL	31.0
21"	FIP	FIP	V76-21-11-66-NL	24.0	V77-21-11-77-NL	32.0
	CTS*	FIP	V76-21-41-66-NL	24.0	V77-21-41-77-NL	32.0
	CTS*	CTS*	V76-21-44-66-NL	24.0	V77-21-44-77-NL	32.5
24"	FIP	FIP	V76-24-11-66-NL	24.0	V77-24-11-77-NL	33.0
	CTS*	FIP	V76-24-41-66-NL	24.0	V77-24-41-77-NL	33.0
	CTS*	CTS*	V76-24-44-66-NL	24.0	V77-24-44-77-NL	33.0
27"	FIP	FIP	V76-27-11-66-NL	25.0	V77-27-11-77-NL	34.0
	CTS*	FIP	V76-27-41-66-NL	25.0	V77-27-41-77-NL	34.0
	CTS*	CTS*	V76-27-44-66-NL	25.0	V77-27-44-77-NL	34.0

Note: 1-1/2" and 2" Coppersetter with a meter ell on the outlet is standard *without* a by-pass.

* Grip Joint for copper or plastic tube (CTS) is available. Add "-G" to the catalog number.

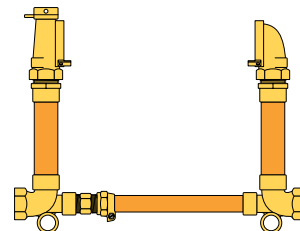

BALL VALVE INLET AND METER ELL OUTLET

HEIGHT	SERVICE LINE CONNECTION		FOR 1-1/2" METER CATALOG NUMBER	APPROX. WT. LBS.	FOR 2" METER CATALOG NUMBER	APPROX. WT. LBS.
	INLET	OUTLET				
12"	FIP	FIP	VB76-12-11-66-NL	21.2	VB77-12-11-77-NL	28.1
	CTS*	FIP	VB76-12-41-66-NL	21.8	VB77-12-41-77-NL	29.2
	CTS*	CTS*	VB76-12-44-66-NL	22.0	VB77-12-44-77-NL	30.2
15"	FIP	FIP	VB76-15-11-66-NL	22.0	VB77-15-11-77-NL	30.0
	CTS*	FIP	VB76-15-41-66-NL	23.0	VB77-15-41-77-NL	30.0
	CTS*	CTS*	VB76-15-44-66-NL	23.3	VB77-15-44-77-NL	31.2
18"	FIP	FIP	VB76-18-11-66-NL	23.0	VB77-18-11-77-NL	32.0
	CTS*	FIP	VB76-18-41-66-NL	24.0	VB77-18-41-77-NL	32.0
	CTS*	CTS*	VB76-18-44-66-NL	24.0	VB77-18-44-77-NL	32.5
21"	FIP	FIP	VB76-21-11-66-NL	24.2	VB77-21-11-77-NL	32.0
	CTS*	FIP	VB76-21-41-66-NL	24.0	VB77-21-41-77-NL	32.0
	CTS*	CTS*	VB76-21-44-66-NL	24.0	VB77-21-44-77-NL	32.0
24"	FIP	FIP	VB76-24-11-66-NL	24.0	VB77-24-11-77-NL	32.0
	CTS*	FIP	VB76-24-41-66-NL	25.0	VB77-24-41-77-NL	33.0
	CTS*	CTS*	VB76-24-44-66-NL	25.0	VB77-24-44-77-NL	34.0
27"	FIP	FIP	VB76-27-11-66-NL	25.4	VB77-27-11-77-NL	35.0
	CTS*	FIP	VB76-27-41-66-NL	25.5	VB77-27-41-77-NL	35.0
	CTS*	CTS*	VB76-27-44-66-NL	25.8	VB77-27-44-77-NL	35.6

Note: 1-1/2" and 2" Coppersetter with a meter ell on the outlet is standard *without* a by-pass.

* Grip Joint for copper or plastic tube (CTS) is available. Add "-G" to the catalog number.

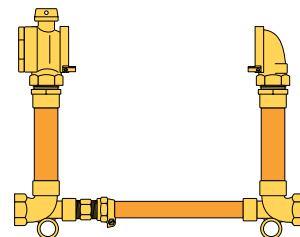

Options Available

Various types of couplings that will adapt to the FIP service line threads can be found on page 42.

Contact factory for heights not listed and availability of No-Rise Coppersetters.

70 Series Coppersetters for 1-1/2" & 2" Flanged Meters

Horizontal Inlet and Outlet

Unless otherwise specified - Standard meter spacing for: 1-1/2" Coppersetters = 13"
2" Coppersetters = 17"

**KEY VALVE INLET AND OUTLET

HEIGHT	SERVICE		FOR 1-1/2" METER CATALOG NUMBER	APPROX. WT. LBS.	FOR 2" METER CATALOG NUMBER	APPROX. WT. LBS.
	LINE CONNECTION					
	INLET	OUTLET				
12"	FIP	FIP	VV76-12B-11-66-NL	25.0	VV77-12B-11-77-NL	30.0
	CTS*	FIP	VV76-12B-41-66-NL	25.0	VV77-12B-41-77-NL	32.0
	CTS*	CTS*	VV76-12B-44-66-NL	25.0	VV77-12B-44-77-NL	34.0
15"	FIP	FIP	VV76-15B-11-66-NL	25.0	VV77-15B-11-77-NL	32.0
	CTS*	FIP	VV76-15B-41-66-NL	26.0	VV77-15B-41-77-NL	33.0
	CTS*	CTS*	VV76-15B-44-66-NL	26.0	VV77-15B-44-77-NL	34.0
18"	FIP	FIP	VV76-18B-11-66-NL	26.0	VV77-18B-11-77-NL	33.0
	CTS*	FIP	VV76-18B-41-66-NL	27.0	VV77-18B-41-77-NL	34.0
	CTS*	CTS*	VV76-18B-44-66-NL	27.0	VV77-18B-44-77-NL	35.0
21"	FIP	FIP	VV76-21B-11-66-NL	27.0	VV77-21B-11-77-NL	34.0
	CTS*	FIP	VV76-21B-41-66-NL	27.0	VV77-21B-41-77-NL	36.0
	CTS*	CTS*	VV76-21B-44-66-NL	27.0	VV77-21B-44-77-NL	37.0
24"	FIP	FIP	VV76-24B-11-66-NL	27.0	VV77-24B-11-77-NL	35.0
	CTS*	FIP	VV76-24B-41-66-NL	27.0	VV77-24B-41-77-NL	37.0
	CTS*	CTS*	VV76-24B-44-66-NL	27.0	VV77-24B-44-77-NL	37.0
27"	FIP	FIP	VV76-27B-11-66-NL	27.4	VV77-27B-11-77-NL	37.0
	CTS*	FIP	VV76-27B-41-66-NL	28.0	VV77-27B-41-77-NL	37.0
	CTS*	CTS*	VV76-27B-44-66-NL	28.0	VV77-27B-44-77-NL	38.0

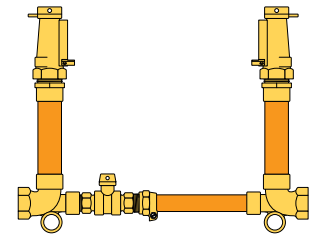

Note: 1-1/2" and 2" Coppersetters with a valve on the outlet are standard **with** a by-pass. The by-pass feature can be removed by omitting the "B" from the middle of the catalog number. Example: VV76-12-11-66-NL

* **Grip Joint** for copper or plastic tube (CTS) is available. Add "-G" to the catalog number.

** 1-1/2" and 2" outlet ball valves may be used as customer shut-offs (on customer side of the meter). The flange inverted key angle valves should **not** be used as customer shut-offs on the customer side of the meter.

BALL VALVE INLET AND OUTLET

HEIGHT	SERVICE		FOR 1-1/2" METER CATALOG NUMBER	APPROX. WT. LBS.	FOR 2" METER CATALOG NUMBER	APPROX. WT. LBS.
	LINE CONNECTION					
	INLET	OUTLET				
12"	FIP	FIP	VBB76-12B-11-66-NL	26.0	VBB77-12B-11-77-NL	35.0
	CTS*	FIP	VBB76-12B-41-66-NL	27.0	VBB77-12B-41-77-NL	35.0
	CTS*	CTS*	VBB76-12B-44-66-NL	28.0	VBB77-12B-44-77-NL	36.1
15"	FIP	FIP	VBB76-15B-11-66-NL	26.6	VBB77-15B-11-77-NL	35.0
	CTS*	FIP	VBB76-15B-41-66-NL	27.8	VBB77-15B-41-77-NL	36.3
	CTS*	CTS*	VBB76-15B-44-66-NL	28.2	VBB77-15B-44-77-NL	37.0
18"	FIP	FIP	VBB76-18B-11-66-NL	27.2	VBB77-18B-11-77-NL	35.7
	CTS*	FIP	VBB76-18B-41-66-NL	28.1	VBB77-18B-41-77-NL	37.3
	CTS*	CTS*	VBB76-18B-44-66-NL	28.8	VBB77-18B-44-77-NL	38.0
21"	FIP	FIP	VBB76-21B-11-66-NL	27.8	VBB77-21B-11-77-NL	36.6
	CTS*	FIP	VBB76-21B-41-66-NL	28.0	VBB77-21B-41-77-NL	38.0
	CTS*	CTS*	VBB76-21B-44-66-NL	28.0	VBB77-21B-44-77-NL	39.0
24"	FIP	FIP	VBB76-24B-11-66-NL	28.5	VBB77-24B-11-77-NL	37.6
	CTS*	FIP	VBB76-24B-41-66-NL	30.0	VBB77-24B-41-77-NL	39.0
	CTS*	CTS*	VBB76-24B-44-66-NL	30.5	VBB77-24B-44-77-NL	40.0
27"	FIP	FIP	VBB76-27B-11-66-NL	29.1	VBB77-27B-11-77-NL	38.5
	CTS*	FIP	VBB76-27B-41-66-NL	30.0	VBB77-27B-41-77-NL	39.0
	CTS*	CTS*	VBB76-27B-44-66-NL	30.7	VBB77-27B-44-77-NL	40.7

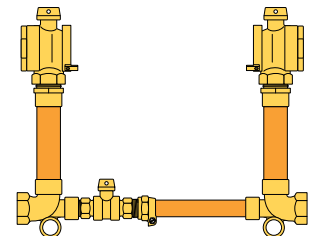

Note: 1-1/2" and 2" Coppersetters with a valve on the outlet are standard **with** a by-pass. The by-pass feature can be removed by omitting the "B" from the middle of the catalog number. Example: VBB76-12-11-66-NL

* **Grip Joint** for copper or plastic tube (CTS) is available. Add "-G" to the catalog number.

Options Available

An optional high by-pass is available when standard by-pass is difficult to reach, see page 41.

Various types of couplings that will adapt to the FIP service line threads can be found on page 42.

Contact factory for heights not listed and availability of No-Rise Coppersetters.

70 Series Coppersetters for 1-1/2" & 2" Flanged Meters

Horizontal Inlet and Outlet

Unless otherwise specified - Standard meter spacing for: 1-1/2" Coppersetters = 13"
2" Coppersetters = 17"

KEY VALVE INLET AND ANGLE CHECK VALVE OUTLET

HEIGHT	SERVICE LINE CONNECTION		FOR 1-1/2" METER CATALOG NUMBER	APPROX. Wt. LBS.	FOR 2" METER CATALOG NUMBER	APPROX. Wt. LBS.
	INLET	OUTLET				
12"	FIP	FIP	VH76-12B-11-66-NL	25.0	VH77-12B-11-77-NL	31.0
	CTS*	FIP	VH76-12B-41-66-NL	26.0	VH77-12B-41-77-NL	32.0
	CTS*	CTS*	VH76-12B-44-66-NL	26.0	VH77-12B-44-77-NL	33.0
15"	FIP	FIP	VH76-15B-11-66-NL	25.0	VH77-15B-11-77-NL	32.0
	CTS*	FIP	VH76-15B-41-66-NL	26.0	VH77-15B-41-77-NL	34.0
	CTS*	CTS*	VH76-15B-44-66-NL	27.0	VH77-15B-44-77-NL	34.0
18"	FIP	FIP	VH76-18B-11-66-NL	26.0	VH77-18B-11-77-NL	33.0
	CTS*	FIP	VH76-18B-41-66-NL	27.0	VH77-18B-41-77-NL	34.0
	CTS*	CTS*	VH76-18B-44-66-NL	28.0	VH77-18B-44-77-NL	35.0
21"	FIP	FIP	VH76-21B-11-66-NL	27.0	VH77-21B-11-77-NL	34.0
	CTS*	FIP	VH76-21B-41-66-NL	28.0	VH77-21B-41-77-NL	35.0
	CTS*	CTS*	VH76-21B-44-66-NL	28.0	VH77-21B-44-77-NL	35.0
24"	FIP	FIP	VH76-24B-11-66-NL	27.2	VH77-24B-11-77-NL	35.0
	CTS*	FIP	VH76-24B-41-66-NL	28.0	VH77-24B-41-77-NL	36.0
	CTS*	CTS*	VH76-24B-44-66-NL	28.0	VH77-24B-44-77-NL	36.0
27"	FIP	FIP	VH76-27B-11-66-NL	28.0	VH77-27B-11-77-NL	36.0
	CTS*	FIP	VH76-27B-41-66-NL	29.0	VH77-27B-41-77-NL	37.0
	CTS*	CTS*	VH76-27B-44-66-NL	29.4	VH77-27B-44-77-NL	38.0

Note: 1-1/2" and 2" Coppersetters with a valve on the outlet are standard **with** a by-pass. The by-pass feature can be removed by omitting the "B" from the middle of the catalog number. Example: VH76-12-11-66-NL.

* **Grip Joint** for copper or plastic tube (CTS) is available. Add "-G" to the catalog number.

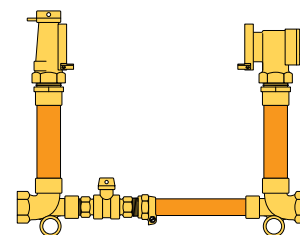

BALL VALVE INLET AND ANGLE CHECK VALVE OUTLET

HEIGHT	SERVICE LINE CONNECTION		FOR 1-1/2" METER CATALOG NUMBER	APPROX. Wt. LBS.	FOR 2" METER CATALOG NUMBER	APPROX. Wt. LBS.
	INLET	OUTLET				
12"	FIP	FIP	VBH76-12B-11-66-NL	25.6	VBH77-12B-11-77-NL	32.0
	CTS*	FIP	VBH76-12B-41-66-NL	26.0	VBH77-12B-41-77-NL	33.7
	CTS*	CTS*	VBH76-12B-44-66-NL	27.0	VBH77-12B-44-77-NL	35.0
15"	FIP	FIP	VBH76-15B-11-66-NL	27.0	VBH77-15B-11-77-NL	34.0
	CTS*	FIP	VBH76-15B-41-66-NL	28.0	VBH77-15B-41-77-NL	36.0
	CTS*	CTS*	VBH76-15B-44-66-NL	27.0	VBH77-15B-44-77-NL	36.0
18"	FIP	FIP	VBH76-18B-11-66-NL	28.0	VBH77-18B-11-77-NL	35.0
	CTS*	FIP	VBH76-18B-41-66-NL	29.0	VBH77-18B-41-77-NL	37.0
	CTS*	CTS*	VBH76-18B-44-66-NL	30.0	VBH77-18B-44-77-NL	37.0
21"	FIP	FIP	VBH76-21B-11-66-NL	29.0	VBH77-21B-11-77-NL	36.0
	CTS*	FIP	VBH76-21B-41-66-NL	30.0	VBH77-21B-41-77-NL	36.0
	CTS*	CTS*	VBH76-21B-44-66-NL	30.0	VBH77-21B-44-77-NL	37.0
24"	FIP	FIP	VBH76-24B-11-66-NL	29.0	VBH77-24B-11-77-NL	36.0
	CTS*	FIP	VBH76-24B-41-66-NL	30.0	VBH77-24B-41-77-NL	38.0
	CTS*	CTS*	VBH76-24B-44-66-NL	31.0	VBH77-24B-44-77-NL	38.6
27"	FIP	FIP	VBH76-27B-11-66-NL	30.0	VBH77-27B-11-77-NL	37.0
	CTS*	FIP	VBH76-27B-41-66-NL	31.0	VBH77-27B-41-77-NL	39.0
	CTS*	CTS*	VBH76-27B-44-66-NL	32.0	VBH77-27B-44-77-NL	39.5

Note: 1-1/2" and 2" Coppersetters with a valve on the outlet are standard **with** a by-pass. The by-pass feature can be removed by omitting the "B" from the middle of the catalog number. Example: VBH76-12-11-66-NL.

* **Grip Joint** for copper or plastic tube (CTS) is available. Add "-G" to the catalog number.

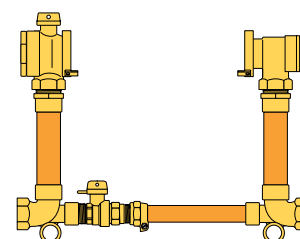

Options Available

An optional high by-pass is available when standard by-pass is difficult to reach, see page 41.

Various types of couplings that will adapt to the FIP service line threads can be found on page 42.

Contact factory for heights not listed and availability of No-Rise Coppersetters.

70 Series Coppersetter for 1-1/2" & 2" Flanged Meters

Horizontal Inlet and Outlet

Unless otherwise specified - Standard meter spacing for: 1-1/2" Coppersetter = 13"
 2" Coppersetter = 17"

KEY VALVE INLET AND ASSE APPROVED ANGLE DUAL CHECK VALVE OUTLET

HEIGHT	SERVICE		FOR 1-1/2" METER CATALOG NUMBER	APPROX. WT. LBS.	FOR 2" METER CATALOG NUMBER	APPROX. WT. LBS.
	LINE CONNECTION					
	INLET	OUTLET				
12"	FIP	FIP	VHH76-12B-11-66-NL	27.0	VHH77-12B-11-77-NL	32.0
	CTS*	FIP	VHH76-12B-41-66-NL	28.0	VHH77-12B-41-77-NL	34.0
	CTS*	CTS*	VHH76-12B-44-66-NL	28.0	VHH77-12B-44-77-NL	35.0
15"	FIP	FIP	VHH76-15B-11-66-NL	28.0	VHH77-15B-11-77-NL	33.0
	CTS*	FIP	VHH76-15B-41-66-NL	28.0	VHH77-15B-41-77-NL	34.0
	CTS*	CTS*	VHH76-15B-44-66-NL	29.0	VHH77-15B-44-77-NL	36.0
18"	FIP	FIP	VHH76-18B-11-66-NL	28.0	VHH77-18B-11-77-NL	34.0
	CTS*	FIP	VHH76-18B-41-66-NL	28.0	VHH77-18B-41-77-NL	36.0
	CTS*	CTS*	VHH76-18B-44-66-NL	29.0	VHH77-18B-44-77-NL	36.0
21"	FIP	FIP	VHH76-21B-11-66-NL	29.0	VHH77-21B-11-77-NL	35.0
	CTS*	FIP	VHH76-21B-41-66-NL	30.0	VHH77-21B-41-77-NL	36.0
	CTS*	CTS*	VHH76-21B-44-66-NL	30.0	VHH77-21B-44-77-NL	36.0
24"	FIP	FIP	VHH76-24B-11-66-NL	30.0	VHH77-24B-11-77-NL	36.0
	CTS*	FIP	VHH76-24B-41-66-NL	31.0	VHH77-24B-41-77-NL	37.0
	CTS*	CTS*	VHH76-24B-44-66-NL	31.0	VHH77-24B-44-77-NL	39.0
27"	FIP	FIP	VHH76-27B-11-66-NL	31.0	VHH77-27B-11-77-NL	37.0
	CTS*	FIP	VHH76-27B-41-66-NL	31.0	VHH77-27B-41-77-NL	38.0
	CTS*	CTS*	VHH76-27B-44-66-NL	32.0	VHH77-27B-44-77-NL	39.0

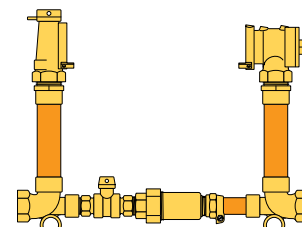

Shown with cartridge dual check valve in by-pass. See information below to order this feature.

Note: 1-1/2" and 2" Coppersetter with a valve on the outlet are standard with a by-pass. The by-pass feature can be removed by omitting the "B" from the middle of the catalog number. Example: VHH76-12-11-66-NL. For by-pass with 1" Cartridge Dual Check Valve, insert "HC" after the "B."
 Example: VHH77-12BHC-11-77-NL.

* **Grip Joint** for copper or plastic tube (CTS) is available. Add "-G" to the catalog number.

BALL VALVE INLET AND ASSE APPROVED ANGLE DUAL CHECK VALVE OUTLET

HEIGHT	SERVICE		FOR 1-1/2" METER CATALOG NUMBER	APPROX. WT. LBS.	FOR 2" METER CATALOG NUMBER	APPROX. WT. LBS.
	LINE CONNECTION					
	INLET	OUTLET				
12"	FIP	FIP	VBHH76-12B-11-66-NL	29.0	VBHH77-12B-11-77-NL	33.0
	CTS*	FIP	VBHH76-12B-41-66-NL	30.0	VBHH77-12B-41-77-NL	35.0
	CTS*	CTS*	VBHH76-12B-44-66-NL	30.0	VBHH77-12B-44-77-NL	36.0
15"	FIP	FIP	VBHH76-15B-11-66-NL	30.0	VBHH77-15B-11-77-NL	34.0
	CTS*	FIP	VBHH76-15B-41-66-NL	30.0	VBHH77-15B-41-77-NL	36.0
	CTS*	CTS*	VBHH76-15B-44-66-NL	31.0	VBHH77-15B-44-77-NL	37.0
18"	FIP	FIP	VBHH76-18B-11-66-NL	30.0	VBHH77-18B-11-77-NL	35.0
	CTS*	FIP	VBHH76-18B-41-66-NL	31.0	VBHH77-18B-41-77-NL	36.0
	CTS*	CTS*	VBHH76-18B-44-66-NL	32.0	VBHH77-18B-44-77-NL	37.0
21"	FIP	FIP	VBHH76-21B-11-66-NL	31.0	VBHH77-21B-11-77-NL	36.0
	CTS*	FIP	VBHH76-21B-41-66-NL	32.0	VBHH77-21B-41-77-NL	37.0
	CTS*	CTS*	VBHH76-21B-44-66-NL	32.0	VBHH77-21B-44-77-NL	38.0
24"	FIP	FIP	VBHH76-24B-11-66-NL	32.0	VBHH77-24B-11-77-NL	37.0
	CTS*	FIP	VBHH76-24B-41-66-NL	33.0	VBHH77-24B-41-77-NL	38.0
	CTS*	CTS*	VBHH76-24B-44-66-NL	33.0	VBHH77-24B-44-77-NL	39.0
27"	FIP	FIP	VBHH76-27B-11-66-NL	32.0	VBHH77-27B-11-77-NL	38.0
	CTS*	FIP	VBHH76-27B-41-66-NL	33.0	VBHH77-27B-41-77-NL	39.0
	CTS*	CTS*	VBHH76-27B-44-66-NL	33.0	VBHH77-27B-44-77-NL	41.0

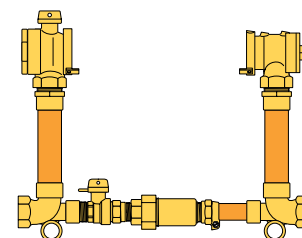

Shown with cartridge dual check valve in by-pass. See information below to order this feature.

Note: 1-1/2" and 2" Coppersetter with a valve on the outlet are standard with a by-pass. The by-pass feature can be removed by omitting the "B" from the middle of the catalog number. Example: VBHH76-12-11-66-NL. For by-pass with 1" Cartridge Dual Check Valve, insert "HC" after the "B."
 Example: VBHH77-12BHC-11-77-NL.

* **Grip Joint** for copper or plastic tube (CTS) is available. Add "-G" to the catalog number.

Options Available

An optional high by-pass is available when standard by-pass is difficult to reach, see page 41.
 Various types of couplings that will adapt to the FIP service line threads can be found on page 42.
 Contact factory for heights not listed and availability of No-Rise Coppersetter.

70-80 Series Coppersetters for 1-1/2" & 2" Flanged Meters

Vertical Inlet and Horizontal Outlet

Unless otherwise specified - Standard meter spacing for: 1-1/2" Coppersetters = 13"
2" Coppersetters = 17"

KEY VALVE INLET AND METER ELL OUTLET

HEIGHT	FOR 1-1/2" METER		FOR 2" METER	
	CATALOG NUMBER	APPROX. WT. LBS.	CATALOG NUMBER	APPROX. WT. LBS.
12"	V76-86-12-11-66-NL	20.0	V77-87-12-11-77-NL	26.0
15"	V76-86-15-11-66-NL	21.0	V77-87-15-11-77-NL	27.0
18"	V76-86-18-11-66-NL	22.0	V77-87-18-11-77-NL	28.0
21"	V76-86-21-11-66-NL	23.0	V77-87-21-11-77-NL	29.0
24"	V76-86-24-11-66-NL	23.0	V77-87-24-11-77-NL	30.0
27"	V76-86-27-11-66-NL	24.0	V77-87-27-11-77-NL	30.0

Note: 1-1/2" and 2" Coppersetters with a meter ell on the outlet are standard **without** a by-pass.

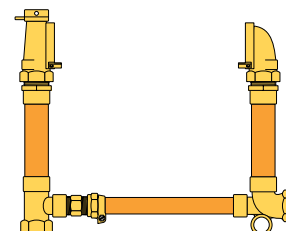

BALL VALVE INLET AND METER ELL OUTLET

HEIGHT	FOR 1-1/2" METER		FOR 2" METER	
	CATALOG NUMBER	APPROX. WT. LBS.	CATALOG NUMBER	APPROX. WT. LBS.
12"	VB76-86-12-11-66-NL	23.0	VB77-87-12-11-77-NL	29.0
15"	VB76-86-15-11-66-NL	24.0	VB77-87-15-11-77-NL	30.0
18"	VB76-86-18-11-66-NL	25.0	VB77-87-18-11-77-NL	30.0
21"	VB76-86-21-11-66-NL	25.0	VB77-87-21-11-77-NL	31.0
24"	VB76-86-24-11-66-NL	26.0	VB77-87-24-11-77-NL	31.0
27"	VB76-86-27-11-66-NL	26.0	VB77-87-27-11-77-NL	32.0

Note: 1-1/2" and 2" Coppersetters with a meter ell on the outlet are standard **without** a by-pass.

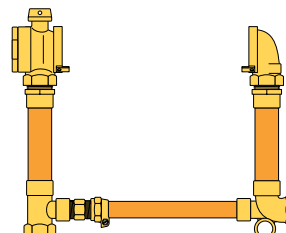

**KEY VALVE INLET AND OUTLET

HEIGHT	FOR 1-1/2" METER		FOR 2" METER	
	CATALOG NUMBER	APPROX. WT. LBS.	CATALOG NUMBER	APPROX. WT. LBS.
12"	VV76-86-12B-11-66-NL	24.0	VV77-87-12B-11-77-NL	31.0
15"	VV76-86-15B-11-66-NL	25.0	VV77-87-15B-11-77-NL	32.0
18"	VV76-86-18B-11-66-NL	26.0	VV77-87-18B-11-77-NL	32.0
21"	VV76-86-21B-11-66-NL	26.0	VV77-87-21B-11-77-NL	33.0
24"	VV76-86-24B-11-66-NL	27.0	VV77-87-24B-11-77-NL	33.0
27"	VV76-86-27B-11-66-NL	28.0	VV77-87-27B-11-77-NL	34.0

Note: 1-1/2" and 2" Coppersetters with a valve on the outlet are standard **with** a by-pass. The by-pass feature can be removed by omitting the "B" from the middle of the catalog number. Example: VV76-86-15-11-66-NL

** 1-1/2" and 2" outlet ball valves may be used as customer shut-offs (on customer side of the meter). The flange inverted key angle valves should **not** be used as customer shut-offs on the customer side of the meter.

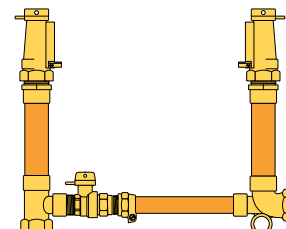

BALL VALVE INLET AND OUTLET

HEIGHT	FOR 1-1/2" METER		FOR 2" METER	
	CATALOG NUMBER	APPROX. WT. LBS.	CATALOG NUMBER	APPROX. WT. LBS.
12"	VBB76-86-12B-11-66-NL	26.0	VBB77-87-12B-11-77-NL	33.0
15"	VBB76-86-15B-11-66-NL	26.0	VBB77-87-15B-11-77-NL	33.0
18"	VBB76-86-18B-11-66-NL	27.0	VBB77-87-18B-11-77-NL	34.0
21"	VBB76-86-21B-11-66-NL	27.0	VBB77-87-21B-11-77-NL	35.0
24"	VBB76-86-24B-11-66-NL	28.0	VBB77-87-24B-11-77-NL	36.0
27"	VBB76-86-27B-11-66-NL	29.0	VBB77-87-27B-11-77-NL	37.0

Note: 1-1/2" and 2" Coppersetters with a valve on the outlet are standard **with** a by-pass. The by-pass feature can be removed by omitting the "B" from the middle of the catalog number. Example: VBB76-86-15-11-66-NL.

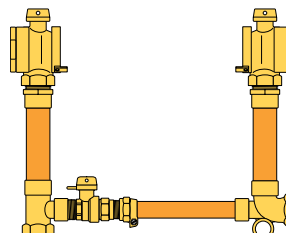

Options Available

An optional high by-pass is available when standard by-pass is difficult to reach, see page 41.
Various types of couplings that will adapt to the FIP service line threads can be found on page 42.
Contact factory for heights not listed and availability of No-Rise Coppersetters.

70-80 Series Coppersettlers for 1-1/2" & 2" Flanged Meters

Vertical Inlet and Horizontal Outlet

Unless otherwise specified - Standard meter spacing for: 1-1/2" Coppersettlers = 13"
2" Coppersettlers = 17"

KEY VALVE INLET AND ANGLE CHECK VALVE OUTLET

HEIGHT	FOR 1-1/2" METER		FOR 2" METER	
	CATALOG NUMBER	APPROX. WT. LBS.	CATALOG NUMBER	APPROX. WT. LBS.
12"	VH76-86-12B-11-66-NL	25.0	VH77-87-12B-11-77-NL	30.0
15"	VH76-86-15B-11-66-NL	26.0	VH77-87-15B-11-77-NL	31.0
18"	VH76-86-18B-11-66-NL	26.0	VH77-87-18B-11-77-NL	32.0
21"	VH76-86-21B-11-66-NL	27.0	VH77-87-21B-11-77-NL	33.0
24"	VH76-86-24B-11-66-NL	27.0	VH77-87-24B-11-77-NL	33.0
27"	VH76-86-27B-11-66-NL	27.0	VH77-87-27B-11-77-NL	33.0

Note: 1-1/2" and 2" Coppersettlers with a valve on the outlet are standard with a by-pass. The by-pass feature can be removed by omitting the "B" from the middle of the catalog number. Example: VH76-86-12-11-66-NL.

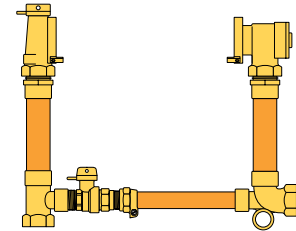

BALL VALVE INLET AND ANGLE CHECK VALVE OUTLET

HEIGHT	FOR 1-1/2" METER		FOR 2" METER	
	CATALOG NUMBER	APPROX. WT. LBS.	CATALOG NUMBER	APPROX. WT. LBS.
12"	VBH76-86-12B-11-66-NL	26.0	VBH77-87-12B-11-77-NL	31.0
15"	VBH76-86-15B-11-66-NL	27.0	VBH77-87-15B-11-77-NL	32.0
18"	VBH76-86-18B-11-66-NL	28.0	VBH77-87-18B-11-77-NL	33.0
21"	VBH76-86-21B-11-66-NL	28.0	VBH77-87-21B-11-77-NL	34.0
24"	VBH76-86-24B-11-66-NL	29.0	VBH77-87-24B-11-77-NL	35.0
27"	VBH76-86-27B-11-66-NL	29.0	VBH77-87-27B-11-77-NL	36.0

Note: 1-1/2" and 2" Coppersettlers with a valve on the outlet are standard with a by-pass. The by-pass feature can be removed by omitting the "B" from the middle of the catalog number. Example: VBH76-86-12-11-66-NL.

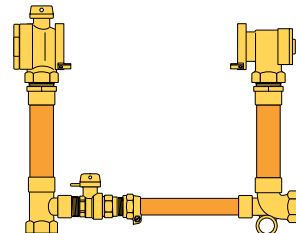

KEY VALVE INLET AND ASSE APPROVED ANGLE DUAL CHECK VALVE OUTLET

HEIGHT	FOR 1-1/2" METER		FOR 2" METER	
	CATALOG NUMBER	APPROX. WT. LBS.	CATALOG NUMBER	APPROX. WT. LBS.
12"	VHH76-86-12B-11-66-NL	25.0	VHH77-87-12B-11-77-NL	31.0
15"	VHH76-86-15B-11-66-NL	25.0	VHH77-87-15B-11-77-NL	31.0
18"	VHH76-86-18B-11-66-NL	26.0	VHH77-87-18B-11-77-NL	32.0
21"	VHH76-86-21B-11-66-NL	26.0	VHH77-87-21B-11-77-NL	32.0
24"	VHH76-86-24B-11-66-NL	27.0	VHH77-87-24B-11-77-NL	33.0
27"	VHH76-86-27B-11-66-NL	27.0	VHH77-87-27B-11-77-NL	33.0

Note: 1-1/2" and 2" Coppersettlers with a valve on the outlet are standard with a by-pass. The by-pass feature can be removed by omitting the "B" from the middle of the catalog number. Example: VHH76-86-12-11-66-NL. For by-pass with 1" cartridge dual check valve, insert "HC" after the "B." Example: VHH76-86-12BHC-11-66-NL.

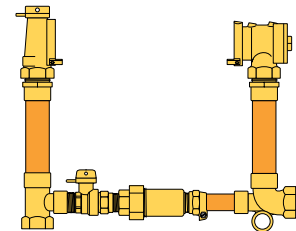

Shown with cartridge dual check valve in by-pass. See information at left to order this feature.

BALL VALVE INLET AND ASSE APPROVED ANGLE DUAL CHECK VALVE OUTLET

HEIGHT	FOR 1-1/2" METER		FOR 2" METER	
	CATALOG NUMBER	APPROX. WT. LBS.	CATALOG NUMBER	APPROX. WT. LBS.
12"	VBHH76-86-12B-11-66-NL	28.0	VBHH77-87-12B-11-77-NL	32.0
15"	VBHH76-86-15B-11-66-NL	29.0	VBHH77-87-15B-11-77-NL	33.0
18"	VBHH76-86-18B-11-66-NL	30.0	VBHH77-87-18B-11-77-NL	34.0
21"	VBHH76-86-21B-11-66-NL	30.0	VBHH77-87-21B-11-77-NL	34.0
24"	VBHH76-86-24B-11-66-NL	31.0	VBHH77-87-24B-11-77-NL	35.0
27"	VBHH76-86-27B-11-66-NL	32.0	VBHH77-87-27B-11-77-NL	36.0

Note: 1-1/2" and 2" Coppersettlers with a valve on the outlet are standard with a by-pass. The by-pass feature can be removed by omitting the "B" from the middle of the catalog number. Example: VBHH76-86-12-11-66-NL. For by-pass with 1" cartridge dual check valve, insert "HC" after the "B." Example: VBHH76-86-12BHC-11-66-NL.

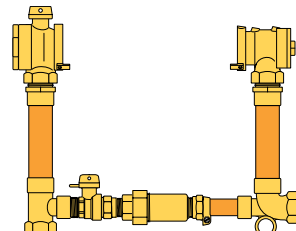

Shown with cartridge dual check valve in by-pass. See information at left to order this feature.

Options Available

An optional high by-pass is available when standard by-pass is difficult to reach, see page 41.

Various types of couplings that will adapt to the FIP service line threads can be found on page 42.

Contact factory for heights not listed and availability of No-Rise Coppersettlers.

80 Series Coppersetters for 1-1/2" & 2" Flanged Meters

Vertical Inlet and Vertical Outlet

Unless otherwise specified - Standard meter spacing for:

1-1/2" Coppersetters = 13"

2" Coppersetters = 17"

KEY VALVE INLET AND METER ELL OUTLET

HEIGHT	FOR 1-1/2" METER		FOR 2" METER	
	CATALOG NUMBER	APPROX. Wt. LBS.	CATALOG NUMBER	APPROX. Wt. LBS.
12"	V86-12-11-66-NL	20.0	V87-12-11-77-NL	24.0
15"	V86-15-11-66-NL	21.0	V87-15-11-77-NL	25.0
18"	V86-18-11-66-NL	21.0	V87-18-11-77-NL	26.0
21"	V86-21-11-66-NL	22.0	V87-21-11-77-NL	26.0
24"	V86-24-11-66-NL	22.0	V87-24-11-77-NL	27.0
27"	V86-27-11-66-NL	23.0	V87-27-11-77-NL	28.0

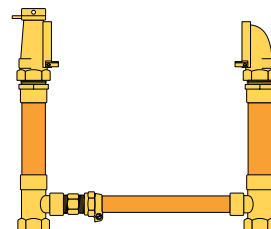

Note: 1-1/2" and 2" Coppersetters with a meter ell on the outlet are standard **without** a by-pass.

BALL VALVE INLET AND METER ELL OUTLET

HEIGHT	FOR 1-1/2" METER		FOR 2" METER	
	CATALOG NUMBER	APPROX. Wt. LBS.	CATALOG NUMBER	APPROX. Wt. LBS.
12"	VB86-12-11-66-NL	22.0	VB87-12-11-77-NL	25.0
15"	VB86-15-11-66-NL	22.0	VB87-15-11-77-NL	26.0
18"	VB86-18-11-66-NL	23.0	VB87-18-11-77-NL	27.0
21"	VB86-21-11-66-NL	24.0	VB87-21-11-77-NL	28.0
24"	VB86-24-11-66-NL	24.0	VB87-24-11-77-NL	28.0
27"	VB86-27-11-66-NL	25.0	VB87-27-11-77-NL	29.0

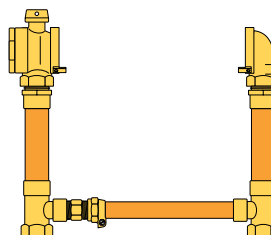

Note: 1-1/2" and 2" Coppersetters with a meter ell on the outlet are standard **without** a by-pass.

**KEY VALVE INLET AND OUTLET

HEIGHT	FOR 1-1/2" METER		FOR 2" METER	
	CATALOG NUMBER	APPROX. Wt. LBS.	CATALOG NUMBER	APPROX. Wt. LBS.
12"	VV86-12B-11-66-NL	23.0	VV87-12B-11-77-NL	27.0
15"	VV86-15B-11-66-NL	24.0	VV87-15B-11-77-NL	28.0
18"	VV86-18B-11-66-NL	24.0	VV87-18B-11-77-NL	28.0
21"	VV86-21B-11-66-NL	25.0	VV87-21B-11-77-NL	29.0
24"	VV86-24B-11-66-NL	26.0	VV87-24B-11-77-NL	29.0
27"	VV86-27B-11-66-NL	27.0	VV87-27B-11-77-NL	30.0

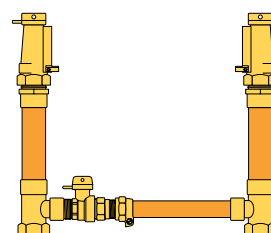

Note: 1-1/2" and 2" Coppersetters with a valve on the outlet are standard **with** a by-pass. The by-pass feature can be removed by omitting the "B" from the middle of the catalog number. Example: VV86-12-11-66-NL

** 1-1/2" and 2" outlet ball valves may be used as customer shut-offs (on customer side of the meter). The flange inverted key angle valves should **not** be used as customer shut-offs on the customer side of the meter.

BALL VALVE INLET AND OUTLET

HEIGHT	FOR 1-1/2" METER		FOR 2" METER	
	CATALOG NUMBER	APPROX. Wt. LBS.	CATALOG NUMBER	APPROX. Wt. LBS.
12"	VBB86-12B-11-66-NL	25.0	VBB87-12B-11-77-NL	30.0
15"	VBB86-15B-11-66-NL	26.0	VBB87-15B-11-77-NL	31.0
18"	VBB86-18B-11-66-NL	26.0	VBB87-18B-11-77-NL	32.0
21"	VBB86-21B-11-66-NL	27.0	VBB87-21B-11-77-NL	33.0
24"	VBB86-24B-11-66-NL	27.0	VBB87-24B-11-77-NL	34.0
27"	VBB86-27B-11-66-NL	28.0	VBB87-27B-11-77-NL	35.0

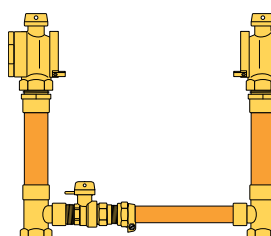

Note: 1-1/2" and 2" Coppersetters with a valve on the outlet are standard **with** a by-pass. The by-pass feature can be removed by omitting the "B" from the middle of the catalog number. Example: VBB86-12-11-66-NL.

Options Available

An optional high by-pass is available when standard by-pass is difficult to reach, see page 41.

Various types of couplings that will adapt to the FIP service line threads can be found on page 42.

Contact factory for heights not listed and availability of No-Rise Coppersetters.

80 Series Copper setters for 1-1/2" & 2" Flanged Meters

Vertical Inlet and Vertical Outlet

Unless otherwise specified - Standard meter spacing for: 1-1/2" Copper setters = 13"
2" Copper setters = 17"

KEY VALVE INLET AND ANGLE CHECK VALVE OUTLET

HEIGHT	FOR 1-1/2" METER		FOR 2" METER	
	CATALOG NUMBER	APPROX. WT. LBS.	CATALOG NUMBER	APPROX. WT. LBS.
12"	VH86-12B-11-66-NL	24.0	VH87-12B-11-77-NL	28.0
15"	VH86-15B-11-66-NL	25.0	VH87-15B-11-77-NL	29.0
18"	VH86-18B-11-66-NL	25.0	VH87-18B-11-77-NL	29.0
21"	VH86-21B-11-66-NL	26.0	VH87-21B-11-77-NL	30.0
24"	VH86-24B-11-66-NL	27.0	VH87-24B-11-77-NL	31.0
27"	VH86-27B-11-66-NL	27.0	VH87-27B-11-77-NL	31.0

Note: 1-1/2" and 2" Copper setters with a valve on the outlet are standard with a by-pass. The by-pass feature can be removed by omitting the "B" from the middle of the catalog number. Example: VH86-12-11-66-NL.

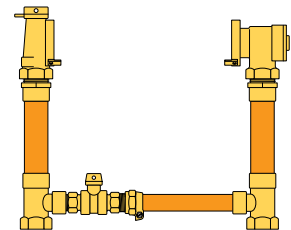

BALL VALVE INLET AND ANGLE CHECK VALVE OUTLET

HEIGHT	FOR 1-1/2" METER		FOR 2" METER	
	CATALOG NUMBER	APPROX. WT. LBS.	CATALOG NUMBER	APPROX. WT. LBS.
12"	VBH86-12B-11-66-NL	24.0	VBH87-12B-11-77-NL	29.0
15"	VBH86-15B-11-66-NL	25.0	VBH87-15B-11-77-NL	30.0
18"	VBH86-18B-11-66-NL	26.0	VBH87-18B-11-77-NL	32.0
21"	VBH86-21B-11-66-NL	26.0	VBH87-21B-11-77-NL	32.0
24"	VBH86-24B-11-66-NL	27.0	VBH87-24B-11-77-NL	33.0
27"	VBH86-27B-11-66-NL	27.0	VBH87-27B-11-77-NL	34.0

Note: 1-1/2" and 2" Copper setters with a valve on the outlet are standard with a by-pass. The by-pass feature can be removed by omitting the "B" from the middle of the catalog number. Example: VBH86-12-11-66-NL.

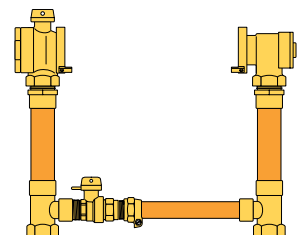

KEY VALVE INLET AND ASSE APPROVED ANGLE DUAL CHECK VALVE OUTLET

HEIGHT	FOR 1-1/2" METER		FOR 2" METER	
	CATALOG NUMBER	APPROX. WT. LBS.	CATALOG NUMBER	APPROX. WT. LBS.
12"	VHH86-12B-11-66-NL	24.0	VHH87-12B-11-77-NL	29.0
15"	VHH86-15B-11-66-NL	25.0	VHH87-15B-11-77-NL	30.0
18"	VHH86-18B-11-66-NL	26.0	VHH87-18B-11-77-NL	31.0
21"	VHH86-21B-11-66-NL	27.0	VHH87-21B-11-77-NL	32.0
24"	VHH86-24B-11-66-NL	28.0	VHH87-24B-11-77-NL	33.0
27"	VHH86-27B-11-66-NL	29.0	VHH87-27B-11-77-NL	34.0

Note: 1-1/2" and 2" Copper setters with a valve on the outlet are standard with a by-pass. The by-pass feature can be removed by omitting the "B" from the middle of the catalog number. Example: VHH86-12-11-66-NL. For by-pass with 1" cartridge dual check valve, insert "HC" after the "B." Example: VHH86-12BHC-11-66-NL.

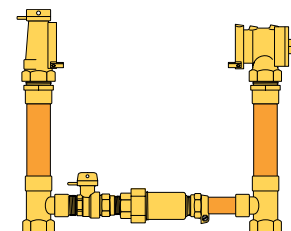

Shown with cartridge dual check valve in by-pass. See information at left to order this feature.

BALL VALVE INLET AND ASSE APPROVED ANGLE DUAL CHECK VALVE OUTLET

HEIGHT	FOR 1-1/2" METER		FOR 2" METER	
	CATALOG NUMBER	APPROX. WT. LBS.	CATALOG NUMBER	APPROX. WT. LBS.
12"	VBHH86-12B-11-66-NL	26.0	VBHH87-12B-11-77-NL	31.0
15"	VBHH86-15B-11-66-NL	27.0	VBHH87-15B-11-77-NL	32.0
18"	VBHH86-18B-11-66-NL	27.0	VBHH87-18B-11-77-NL	32.0
21"	VBHH86-21B-11-66-NL	28.0	VBHH87-21B-11-77-NL	33.0
24"	VBHH86-24B-11-66-NL	28.0	VBHH87-24B-11-77-NL	34.0
27"	VBHH86-27B-11-66-NL	29.0	VBHH87-27B-11-77-NL	34.0

Note: 1-1/2" and 2" Copper setters with a valve on the outlet are standard with a by-pass. The by-pass feature can be removed by omitting the "B" from the middle of the catalog number. Example: VBHH86-12-11-66-NL. For by-pass with 1" cartridge dual check valve, insert "HC" after the "B." Example: VBHH86-12BHC-11-66-NL.

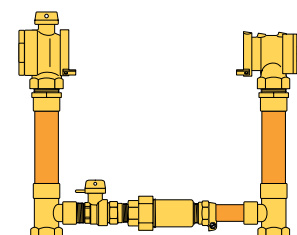

Shown with cartridge dual check valve in by-pass. See information at left to order this feature.

Options Available

An optional high by-pass is available when standard by-pass is difficult to reach, see page 41.

Various types of couplings that will adapt to the FIP service line threads can be found on page 42.

Contact factory for heights not listed and availability of No-Rise Copper setters.

Coppersettors for 1-1/2" & 2" Flanged Meters

Coppersetter Options

Dual Check Valve with Test Port Option

1-1/2" and 2" Coppersettors with an angle dual check valve with a convenient integral 1-1/2" test port for on-site testing allows the utility to confirm meter accuracy without removal of the meter, saving time and money. This option includes a shut-off ball valve (with handle) directly beneath the dual check valve. The shut-off valve isolates the meter from service use. It will also permit service use during the meter test by opening an optional by-pass.

To order: add "-TP6" to the catalog number.

Example: VBHH77-14B-11-77-TP6-NL.

Note: Minimum height with standard by-pass (or no by-pass) is 14".

Minimum height with high by-pass is 18".

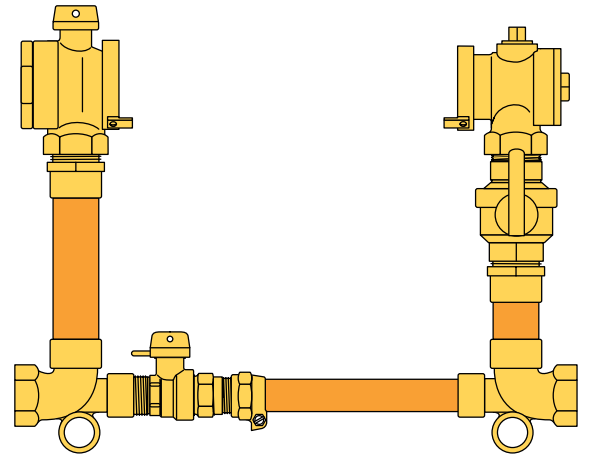

High By-Pass Option

1-1/2" and 2" Coppersettors (minimum 12" height) are available with an optional "high by-pass." This option is popular with taller Coppersettors or when a standard by-pass is difficult to reach.

To order: add "HB" to catalog number.

Example: VV86-18HB-11-66-NL.

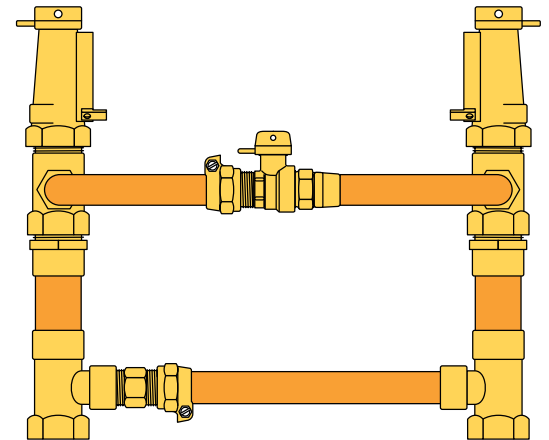

By-Pass With Cartridge Dual Check Valve Option (Available with Standard or High By-Pass Options)

To order: Place "HC" after the "B" by-pass designator.

Examples: Standard by-pass – VBHH87-18BHC-11-77-NL

High by-pass – VBHH87-18HBHC-11-77-NL

Note: Dual check valve option recommended. Drawing at right shows with dual check valve in by-pass.

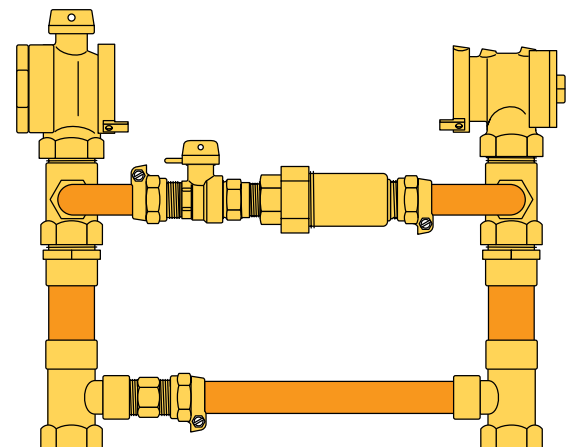

Coppersettors for 1-1/2" & 2" Flanged Meters

Coppersetter Options

1-1/2" & 2" 70 Series Coppersetter Tees

CATALOG NUMBER	DESCRIPTION
○ CSTEE-6-T-CR-NL	1-1/2" Horizontal Inlet Coppersetter Tee
○ CSTEE-7-T-CR-NL	2" Horizontal Inlet Coppersetter Tee
○ CSTEE-6B-T-CR-NL	1-1/2" Horizontal Inlet Coppersetter Tee for by-pass
○ CSTEE-7B-T-CR-NL	2" Horizontal Inlet Coppersetter Tee for by-pass
○ CSTEE-6-S-CR-NL	1-1/2" Horizontal Outlet Coppersetter Tee
○ CSTEE-7-S-CR-NL	2" Horizontal Outlet Coppersetter Tee
○ CSTEE-6B-S-CR-NL	1-1/2" Horizontal Outlet Coppersetter Tee for by-pass
○ CSTEE-7B-S-CR-NL	2" Horizontal Outlet Coppersetter Tee for by-pass

1-1/2" & 2" 80 Series Coppersetter Tees

CATALOG NUMBER	DESCRIPTION
○ T1S1-664-CR-NL	1-1/2" Vertical Inlet/Outlet Coppersetter Tee for By-Pass
○ T1S1-774-CR-NL	2" Vertical Inlet/Outlet Coppersetter Tee for By-Pass

1-1/2" & 2" Coppersetter Bushings and High By-Pass Tees

CATALOG NUMBER	DESCRIPTION
○ CS8-66-CR-NL	1-1/2" Solder valve bushing for 1-1/2" copper
○ CS8-77-CR-NL	2" Solder valve bushing for 2" copper
T184-664-NL	High By-Pass Tee for 1-1/2" Coppersetter
T184-774-NL	High By-Pass Tee for 2" Coppersetter

Optional Couplings

1-1/2" & 2" Coppersettors with FIP only end connections can be connected to other types of service lines by use of the couplings listed below. (complete listing in Catalog Section J)

FOR CONNECTING TO:	1-1/2" COUPLING	2" COUPLING
Copper or Plastic Tube*	C84-66-NL	C84-77-NL
PVC Pipe	C87-66-NL	C87-77-NL
PE Pipe	C86-66-IDR7-NL	C86-77-IDR7-NL
Iron Pipe	C85-66-NL	C85-77-NL
Flared Copper	C28-66-NL	C28-77-NL

* **Grip Joint** for copper or plastic tube (CTS*) is available.

Add "-G" to the catalog number.

- **Attention:** Special solder and procedures are required for best results. Contact factory or see website for installation instructions.

Ford 30 Series Flexible Resetter

Under some conditions the resetting and raising of a too-low meter can be accomplished most easily if the Resetter provides for flexibility in the spacing of the threaded ends which connect to the existing meter couplings. The Flexible Resetter is designed for easy installation in such settings and still maintains proper spacing and alignment for the meter in the raised position. Flexible Resetters are available with a variety of valve options.

To order: Select one Catalog Number component from each of two charts on page 44 to arrive at the complete Resetter Catalog Number. Selection order of components:

- Step 1.** Meter size and valve type
- Step 2.** Resetter height

Example of Catalog Number for a 30 Series Flexible Resetter

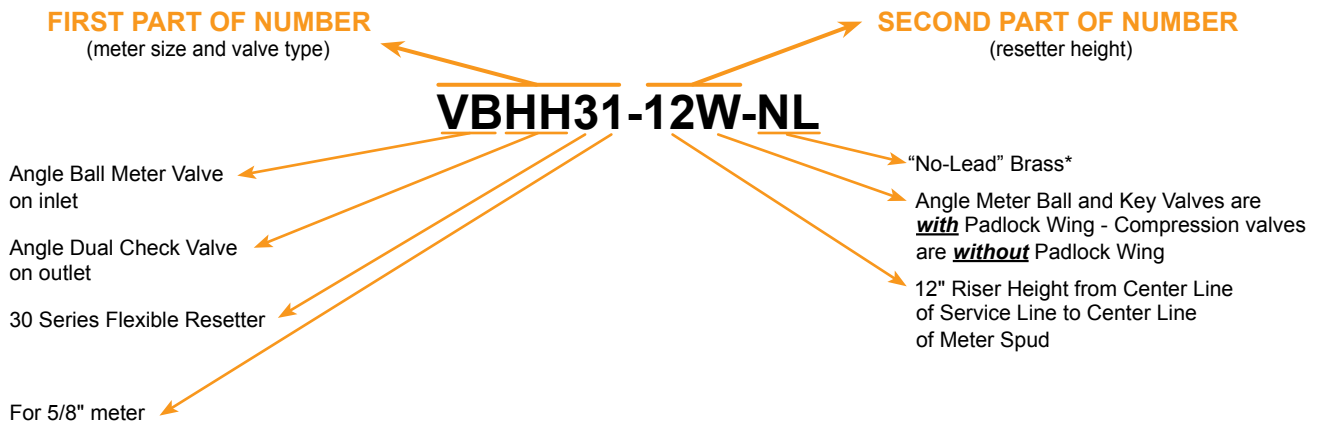

The description for the above catalog number reads: 30 Series Flexible Resetter for 5/8" meter with an Angle Ball Meter Valve on the inlet, and an Angle Dual Check Valve on the outlet, 12 inches high.

* Ford Meter Box no-lead brass products manufactured from UNS/CDA No. 89833 alloy shall contain no more than 0.25% total lead content by weight. United States federal and state laws allow the use of products manufactured from UNS C83600 85-5-5-5 brass alloy for only non-potable water systems within the United States.

NOTES:

1. All valve type setters are standard with padlock wings.
2. All solder joints for Ford meter setters are made with lead-free solder.
3. All 30 Series Flexible Resetters are supplied with meter gaskets and resetter gaskets.
4. Gaskets for Ford meter setters are listed on page 6.

METER SIZE & VALVE TYPE 1ST PART OF CATALOG NUMBER

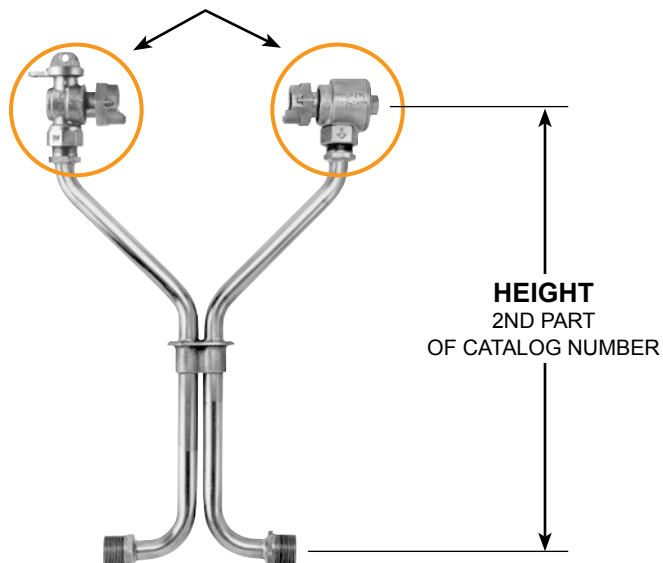

The Ford 30 Series Flexible Resetter

STEP 1. METER SIZE & VALVE TYPE - (FIRST PART OF CATALOG NUMBER)



CATALOG NUMBER (METER SIZE AND VALVE TYPE)				DESCRIPTION	
FOR 5/8"	FOR 5/8" X 3/4"	FOR 3/4"	FOR 1"	INLET VALVE	OUTLET VALVE
31	32	33	34	None	None
V31	V32	V33	V34	Key	None
VB31	VB32	VB33	VB34	Ball	None
VBB31***	VBB32***	VBB33	VBB34	Ball	Ball
VVG31*	VVG32*	VVG33*	VVG34*	Key	Compression
VV31	VV32	VV33	VV34	Key	Key
VH31	VH32	VH33	VH34	Key	Single Check
VHH31	VHH32	VHH33	VHH34▼	Key	Cascading Dual Check
VHC31**	VHC32**	VHC33**	VHC34**	Key	● Cartridge Dual Check
VBH31	VBH32	VBH33	VBH34	Ball	Single Check
VBHH31	VBHH32	VBHH33	VBHH34▼	Ball	Cascading Dual Check
VBHC31**	VBHC32**	VBHC33**	VBHC34**	Ball	● Cartridge Dual Check

* Compression valve does not have padlock wing.

** 30 Series Flexible Resetters with cartridge dual check valve have a 15" minimum height for 5/8", 5/8" x 3/4" and 3/4" meters and 18" minimum height for 1" meters.

*** The 5/8" port angle ball valve is a one-way directional valve designed for the inlet side of the meter and should not be used as a customer shut-off on the customer side of the meter.

▼ Angle cascading dual check valves contain 3/4" internal components. This valve meets the ASSE flow requirements of a 1" valve. For a full port valve, order the cartridge style check valve.

- Cartridges with enhanced chlorine/chloramine resistance are available. Add "CR" to end of alpha code. Example: VHCCR32-15W-NL

Note: Setters with angle ball valve will be reduced port unless otherwise requested.

Reduced port valves usually provide suitable water flow. (Add "-FP" to the catalog number for full port.)

Meter Valve Options for 30 Series Flexible Resetters: Seal wire hole in inlet valve, seal wire hole in check valve

STEP 2. HEIGHT - (SECOND PART OF CATALOG NUMBER)

NOTE: Height dimensions are approximate.

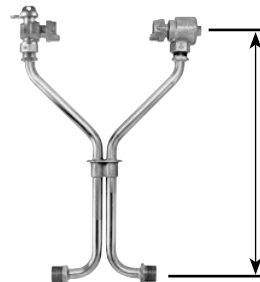

For 5/8", 5/8"x3/4" and 3/4" Meter

CATALOG NUMBER	HEIGHT IN INCHES
12W-NL	12
15W-NL	15
18W-NL	18
21W-NL	21
24W-NL	24

For 1" Meter

CATALOG NUMBER	HEIGHT IN INCHES
15W-NL	15
18W-NL	18
21W-NL	21
24W-NL	24

HEIGHT OPTION FOR 30 SERIES COPPERSETTERS

Coppersettters are available in heights over 24" in 3" increments; 27", 30", 33" etc.

To order put desired height in catalog number. EXAMPLE: V32-33W-NL is a 33" high setter.

The Ford 40 Series Resetter

Correcting low settings with the Ford Resetter is quick and easy. The meter is removed, the Resetter bar connected in the position formerly occupied by the meter, and the meter reset in the raised position. No new pipe joints are necessary. The reset meter is cleaner, easier to read, and much simpler to change.

When the old service valve is in poor condition or poor location, the Resetter with one or two valves provides convenient control, putting the valve or valves at the most accessible location. An outlet valve prevents draining the customer's service when the meter is removed. Resetters, either plain or valve type, are inexpensive when compared to any other means of obtaining these results.

The brass bar of the Resetter is the same length and has the same threads as the meter to be reset. Gaskets are furnished for connecting the bar between the old meter couplings. Refer to page 7 for Tie Bar requirements for Resetter heights above 15".

To order: Select one catalog number component from each of two charts on page 48 to arrive at the complete Resetter catalog number. Selection order of components:

- Step 1.** Meter size and valve type
- Step 2.** Resetter height

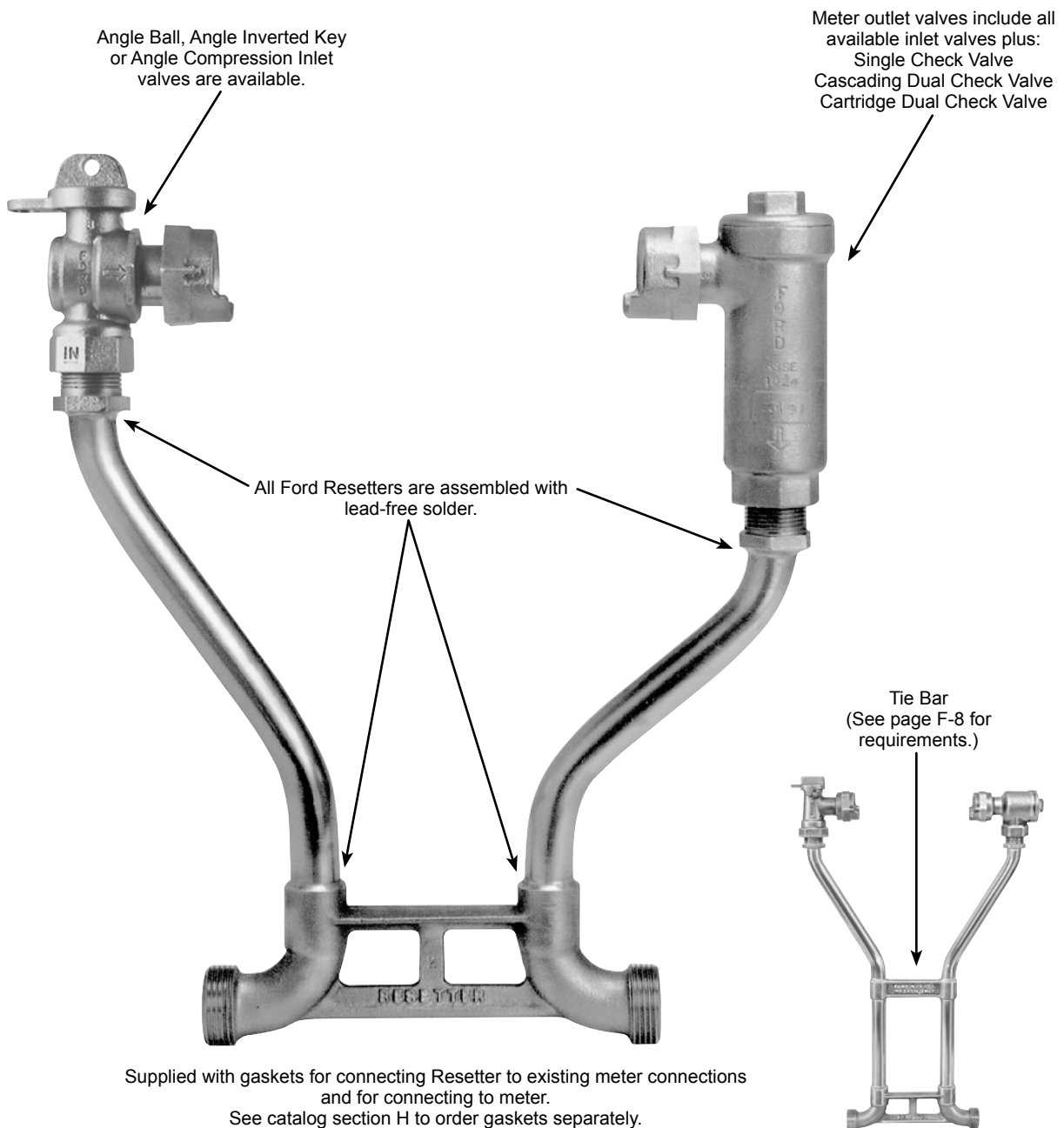

The Ford 40 Series Resetter

Before

This drawing is typical of the position (but not the condition) of meters set too low. Such meters are frequently covered by mud or water, are difficult to read quickly and accurately and, being troublesome to change, tend to be left in place when needing repair.

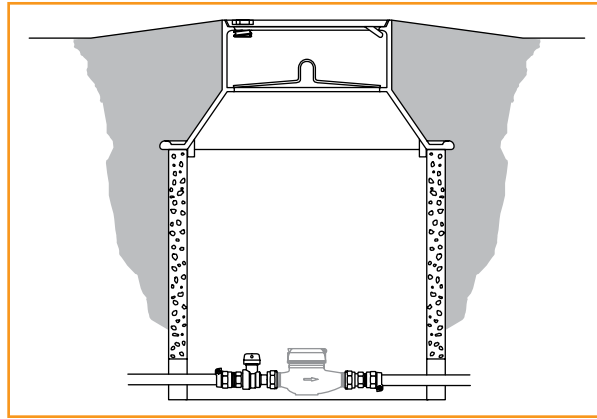

After

The benefit of the Resetter is shown below. The meter stays cleaner, is easier to read and much easier to change. The valve, included on the Resetter in this case, is easily accessible. The economic return of resetting meters can be surprisingly substantial.

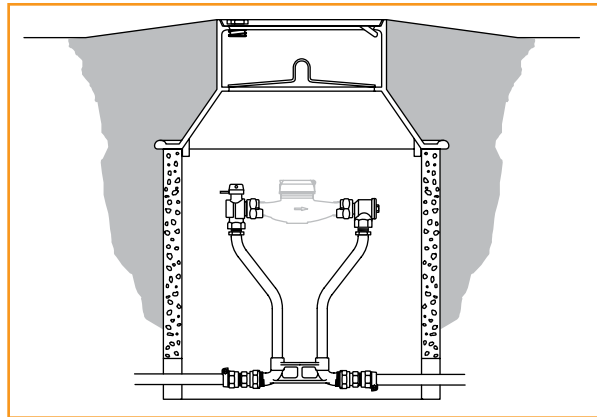

Change-over Resetters

Many water utilities are changing domestic meter sizes from 5/8" to 5/8"x3/4". For raising a too-low meter and converting to the larger meter, the Resetter has a 5/8" bottom bar and 5/8"x3/4" coupling nuts. To order a Change-over Resetter place a "B" at the end of the catalog number. Example: V42-7W-B1-NL is a Change-over Resetter to replace a 5/8" meter with a 5/8"x3/4" meter. Special Resetters are also available for reducing from 3/4" to 5/8"x3/4" or from 1" to 3/4". Solutions to many meter resetting problems are considered upon request.

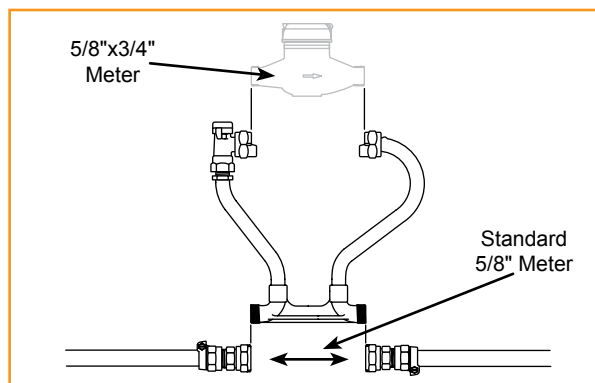

The Ford 40 Series Resetter

Example of Catalog Number for a Resetter

FIRST PART OF NUMBER
(meter size and valve type)

SECOND PART OF NUMBER
(resetter height)

VBHC42-12W-B1-NL

Angle Ball Meter Valve
on inlet

Angle Cartridge Dual Check
on outlet

Resetter

For 5/8" x 3/4" meter

"No-Lead" Brass*

Optional change-over bottom bar
changes 5/8" meter setting to a
5/8" x 3/4" meter setting

Angle Meter Ball and Key Valves are
with Padlock Wing - Compression
valves are **without** Padlock Wing

12" Riser Height from center line
of initial meter setting to
center line of reset meter spud

The description for the above catalog number reads: Resetter for replacing a 5/8" meter with a 5/8" x 3/4" meter with an Angle Ball Meter Valve on the inlet, and an Angle Cartridge Dual Check on the outlet, 12 inches high.

* Ford Meter Box no-lead brass products manufactured from UNS/CDA No. 89833 alloy shall contain no more than 0.25% total lead content by weight. United States federal and state laws allow the use of products manufactured from UNS C83600 85-5-5-5 brass alloy for only non-potable water systems within the United States.

NOTES:

1. All valve type setters are standard with padlock wings.
2. All solder joints for Ford meter setters are made with lead-free solder.
3. All 40 series resetters are supplied with meter gaskets and resetter gaskets.
4. Gaskets for Ford meter setters are listed on page 6.

Catalog Numbering

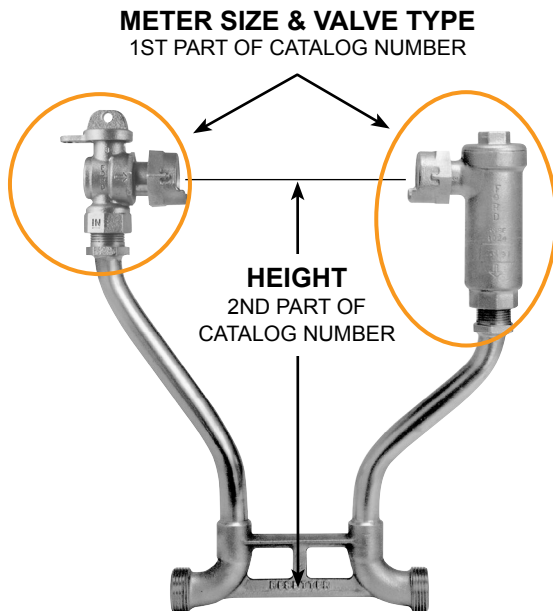

Dimensions

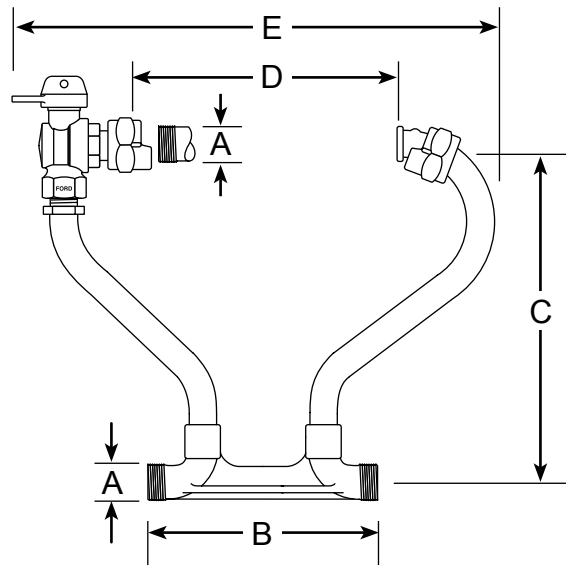

DIMENSION	METER SIZE			
	5/8"	5/8"x3/4"	3/4"	1"
A	1-1/16"	1-5/16"	1-5/16"	1-5/8"
B	7-1/2"	7-1/2"	9"	10-3/4"
C	Heights are as ordered			
D	7-1/2"+3/8"	7-1/2"+3/8"	9"+3/8"	10-3/4"+3/8"
E	12"	12"	14-1/4"	17-1/4"

The Ford 40 Series Resetter

STEP 1. METER SIZE & VALVE TYPE - (FIRST PART OF CATALOG NUMBER)

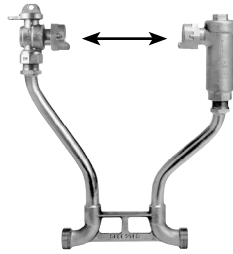

CATALOG NUMBER (METER SIZE AND VALVE TYPE)				DESCRIPTION	
FOR 5/8"	FOR 5/8"x 3/4"	FOR 3/4"	FOR 1"	INLET VALVE	OUTLET VALVE
41	42	43	44	None	None
V41	V42	V43	V44	Key	None
VB41	VB42	VB43	VB44	Ball	None
VBB41***	VBB42***	VBB43	VBB44	Ball	Ball
VV41	VV42	VV43	VV44	Key	Key
VVG41*	VVG42*	VVG43*	VVG44*	Key	Compression
VH41	VH42	VH43	VH44	Key	Single Check
VHH41	VHH42	VHH43	VHH44▼	Key	Cascading Dual Check
VHC41**	VHC42**	VHC43**	VHC44**	Key	● Cartridge Dual Check
VBH41	VBH42	VBH43	VBH44	Ball	Single Check
VBHH41	VBHH42	VBHH43	VBHH44▼	Ball	Cascading Dual Check
VBHC41**	VBHC42**	VBHC43**	VBHC44**	Ball	● Cartridge Dual Check

* Compression valve does not have padlock wing.

** Resetters with dual cartridge check valve have a 9" minimum height for 5/8" and 5/8" x 3/4" meter, 12" minimum height for 3/4" and 1" meters.

*** The 5/8" port angle ball valve is a one-way directional valve designed for the inlet side of the meter and should not be used as a customer shut-off on the customer side of the meter.

▼ Angle cascading dual check valves contain 3/4" internal components. This valve meets the ASSE flow requirements of a 1" valve. For a full port valve, order the cartridge style check valve.

● Cartridges with enhanced chlorine/chloramine resistance are available. Add "CR" to end of alpha code. Example: VHC42-CR

Note: Setters with angle ball valve will be reduced port unless otherwise requested.

Reduced port valves usually provide suitable water flow. (Add "-FP" to the catalog number for full port.)

Meter Valve Options for Resetters: Seal wire hole in inlet valve, seal wire hole in check valve

STEP 2. HEIGHT - (SECOND PART OF CATALOG NUMBER)

NOTE: Height dimensions are approximate.

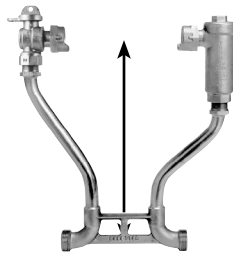

For 5/8" and 5/8"x3/4" Meter

CATALOG NUMBER	HEIGHT IN INCHES
7W-NL	7
9W-NL	9
12W-NL	12
15W-NL	15
18W-NL	18
21W-NL	21
24W-NL	24

For 3/4" Meter

CATALOG NUMBER	HEIGHT IN INCHES
8W-NL	8
12W-NL	12
15W-NL	15
18W-NL	18
21W-NL	21
24W-NL	24

For 1" Meter

CATALOG NUMBER	HEIGHT IN INCHES
10W-NL	10
12W-NL	12
15W-NL	15
18W-NL	18
21W-NL	21
24W-NL	24

HEIGHT INFORMATION FOR 40 SERIES COPPERSETTERS:

- Contact factory for availability of heights not listed.
- Resetters are available in heights over 24" in 3" increments; 27", 30", 33" etc. To order, put desired height in catalog number. Example: V42-30W-NL is a 30" high Resetter.
- See table on page 8 for Tie Bar requirements.

Reseters for 1-1/2" & 2" Flanged Meters

Information for Reseters

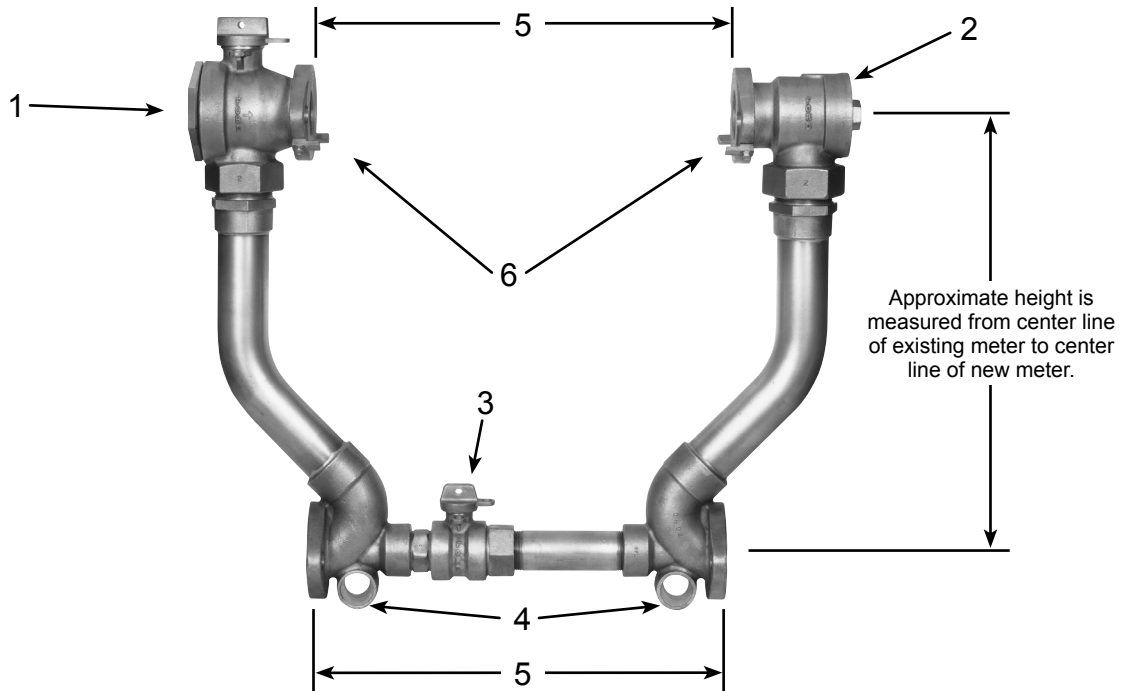

Specifications:

Ford Reseters are constructed from UNS/CDA No. C89833 no-lead brass alloy (AWWA specification C800) and copper tubing. All 1-1/2" and 2" Ford Reseters are individually factory tested for water-tightness before shipment.

Individualized resetting requirements can be satisfied using special Ford Reseters. We welcome the opportunity to solve your 1-1/2" and 2" resetting problems.

1. Inlet valve options are a flanged angle inverted key or flanged angle ball valve.
2. All inlet valve options available on outlet* (see note below) - flanged angle check valve or flanged angle dual check valve is available.
3. Optional by-pass includes a Ford Ball Valve with padlock wings.
4. Brace pipe eyelets are standard - brace pipe not included.
5. Different bottom and top flange spacing may be specified. Standard spacing for 1-1/2" meter Reseters is 13", 17" for 2" meter Resetter.
6. All 1-1/2" and 2" meter flange valves on Copperseters have meter support brackets.

Resetters for 1-1/2" & 2" Flanged Meters

Without By-Pass

Standard meter spacing for 1-1/2" and 2" resetters will be 13" and 17" respectively unless otherwise specified.

RESETTER WITHOUT BY-PASS

FLANGED KEY VALVE ON INLET AND FLANGED METER ELL ON OUTLET

HEIGHT	FOR 1-1/2" METER CATALOG NUMBER	APPROX. WT. LBS.	HEIGHT	FOR 2" METER CATALOG NUMBER	APPROX. WT. LBS.
13"	V46-13-NL	24.0	12"	V47-12-NL	33.0
15"	V46-15-NL	24.0	14"	V47-14-NL	33.0
18"	V46-18-NL	25.0	18"	V47-18-NL	33.0
24"	V46-24-NL	26.0	24"	V47-24-NL	35.0
27"	V46-27-NL	26.0	27"	V47-27-NL	36.0

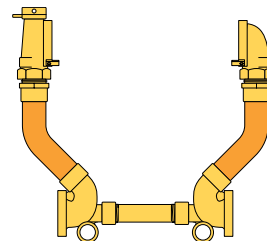

RESETTER WITHOUT BY-PASS

**FLANGED KEY VALVE ON INLET AND OUTLET

HEIGHT	FOR 1-1/2" METER CATALOG NUMBER	APPROX. WT. LBS.	HEIGHT	FOR 2" METER CATALOG NUMBER	APPROX. WT. LBS.
13"	VV46-13-NL	26.0	12"	VV47-12-NL	36.0
15"	VV46-15-NL	26.0	14"	VV47-14-NL	36.0
18"	VV46-18-NL	26.0	18"	VV47-18-NL	36.0
24"	VV46-24-NL	28.0	24"	VV47-24-NL	38.0
27"	VV46-27-NL	29.0	27"	VV47-27-NL	39.0

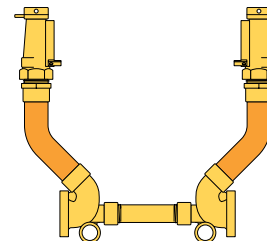

** 1-1/2" and 2" outlet ball valves may be used as customer shut-offs (on customer side of the meter). The flange inverted key angle valves should **not** be used as customer shut-offs on the customer side of the meter.

RESETTER WITHOUT BY-PASS

FLANGED BALL VALVE ON INLET AND OUTLET

HEIGHT	FOR 1-1/2" METER CATALOG NUMBER	APPROX. WT. LBS.	HEIGHT	FOR 2" METER CATALOG NUMBER	APPROX. WT. LBS.
14"	VBB46-14-NL	28.0	14"	VBB47-14-NL	39.0
16"	VBB46-16-NL	29.0	16"	VBB47-16-NL	39.0
18"	VBB46-18-NL	30.0	18"	VBB47-18-NL	39.0
24"	VBB46-24-NL	31.0	24"	VBB47-24-NL	41.0
27"	VBB46-27-NL	32.0	27"	VBB47-27-NL	41.0

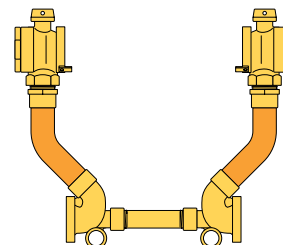

Reseters for 1-1/2" & 2" Flanged Meters

Without By-Pass

Standard meter spacing for 1-1/2" and 2" reseters will be 13" and 17" respectively unless otherwise specified.

RESETTER WITHOUT BY-PASS

FLANGED KEY VALVE ON INLET AND ANGLE CHECK VALVE ON OUTLET

HEIGHT	FOR 1-1/2" METER CATALOG NUMBER	APPROX. WT. LBS.	HEIGHT	FOR 2" METER CATALOG NUMBER	APPROX. WT. LBS.
13"	VH46-13-NL	27.0	13"	VH47-13-NL	37.0
15"	VH46-15-NL	27.0	16"	VH47-16-NL	37.0
18"	VH46-18-NL	27.0	18"	VH47-18-NL	37.0
24"	VH46-24-NL	28.0	24"	VH47-24-NL	38.0
27"	VH46-27-NL	29.0	27"	VH47-27-NL	39.0

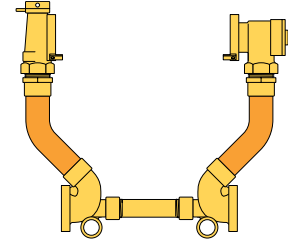

RESETTER WITHOUT BY-PASS FLANGED KEY VALVE ON INLET AND ASSE APPROVED ANGLE DUAL CHECK VALVE ON OUTLET

HEIGHT	FOR 1-1/2" METER CATALOG NUMBER	APPROX. WT. LBS.	HEIGHT	FOR 2" METER CATALOG NUMBER	APPROX. WT. LBS.
13"	VHH46-13-NL	28.0	13"	VHH47-13-NL	37.0
15"	VHH46-15-NL	28.0	16"	VHH47-16-NL	37.0
18"	VHH46-18-NL	29.0	18"	VHH47-18-NL	37.0
24"	VHH46-24-NL	30.0	24"	VHH47-24-NL	39.0
27"	VHH46-27-NL	31.0	27"	VHH47-27-NL	40.0

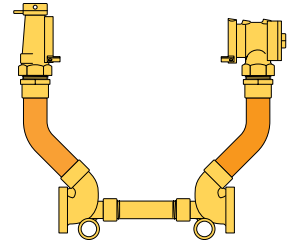

RESETTER WITHOUT BY-PASS

FLANGED BALL VALVE ON INLET AND ANGLE CHECK VALVE OUTLET

HEIGHT	FOR 1-1/2" METER CATALOG NUMBER	APPROX. WT. LBS.	HEIGHT	FOR 2" METER CATALOG NUMBER	APPROX. WT. LBS.
14"	VBH46-14-NL	28.0	14"	VBH47-14-NL	39.0
16"	VBH46-16-NL	28.0	16"	VBH47-16-NL	39.0
18"	VBH46-18-NL	28.0	18"	VBH47-18-NL	39.0
24"	VBH46-24-NL	30.0	24"	VBH47-24-NL	41.0
27"	VBH46-27-NL	31.0	27"	VBH47-27-NL	42.0

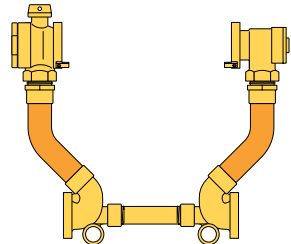

RESETTER WITHOUT BY-PASS FLANGED BALL VALVE ON INLET AND ASSE APPROVED ANGLE DUAL CHECK VALVE OUTLET

HEIGHT	FOR 1-1/2" METER CATALOG NUMBER	APPROX. WT. LBS.	HEIGHT	FOR 2" METER CATALOG NUMBER	APPROX. WT. LBS.
14"	VBHH46-14-NL	30.0	14"	VBHH47-14-NL	39.0
16"	VBHH46-16-NL	30.0	16"	VBHH47-16-NL	39.0
18"	VBHH46-18-NL	31.0	18"	VBHH47-18-NL	39.0
24"	VBHH46-24-NL	32.0	24"	VBHH47-24-NL	41.0
27"	VBHH46-27-NL	33.0	27"	VBHH47-27-NL	42.0

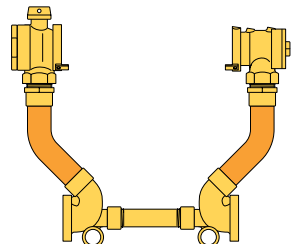

Reseters for 1-1/2" & 2" Flanged Meters

With By-Pass

Standard meter spacing for 1-1/2" and 2" reseters will be 13" and 17" respectively unless otherwise specified.

RESETTER WITH BY-PASS

**FLANGED KEY VALVE ON INLET AND OUTLET

HEIGHT	FOR 1-1/2" METER CATALOG NUMBER	APPROX. WT. LBS.	HEIGHT	FOR 2" METER CATALOG NUMBER	APPROX. WT. LBS.
13"	VV46-13B-NL	29.0	12"	VV47-12B-NL	36.0
15"	VV46-15B-NL	30.0	14"	VV47-14B-NL	37.0
18"	VV46-18B-NL	31.0	18"	VV47-18B-NL	38.0
24"	VV46-24B-NL	32.0	24"	VV47-24B-NL	39.0
27"	VV46-27B-NL	33.0	27"	VV47-27B-NL	40.0

** 1-1/2" and 2" outlet ball valves may be used as customer shut-offs (on customer side of the meter). The flange inverted key angle valves should **not** be used as customer shut-offs on the customer side of the meter.

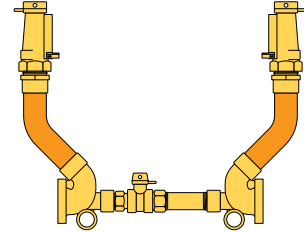

RESETTER WITH BY-PASS

FLANGED BALL VALVE ON INLET AND OUTLET

HEIGHT	FOR 1-1/2" METER CATALOG NUMBER	APPROX. WT. LBS.	HEIGHT	FOR 2" METER CATALOG NUMBER	APPROX. WT. LBS.
14"	VBB46-14B-NL	30.0	14"	VBB47-14B-NL	41.0
16"	VBB46-16B-NL	30.0	16"	VBB47-16B-NL	41.0
18"	VBB46-18B-NL	31.0	18"	VBB47-18B-NL	42.0
24"	VBB46-24B-NL	32.0	24"	VBB47-24B-NL	43.0
27"	VBB46-27B-NL	33.0	27"	VBB47-27B-NL	44.0

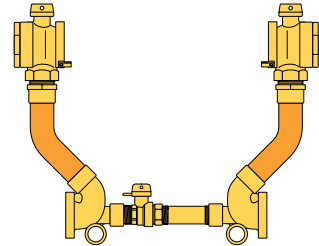

RESETTER WITH BY-PASS

FLANGED KEY VALVE ON INLET AND ANGLE CHECK VALVE ON OUTLET

HEIGHT	FOR 1-1/2" METER CATALOG NUMBER	APPROX. WT. LBS.	HEIGHT	FOR 2" METER CATALOG NUMBER	APPROX. WT. LBS.
13"	VH46-13B-NL	29.0	13"	VH47-13B-NL	37.0
15"	VH46-15B-NL	29.0	16"	VH47-16B-NL	38.0
18"	VH46-18B-NL	29.0	18"	VH47-18B-NL	39.0
24"	VH46-24B-NL	30.0	24"	VH47-24B-NL	40.0
27"	VH46-27B-NL	31.0	27"	VH47-27B-NL	41.0

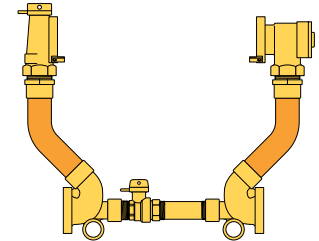

RESETTER WITH BY-PASS FLANGED KEY VALVE ON INLET AND ASSE APPROVED ANGLE DUAL CHECK VALVE ON OUTLET

HEIGHT	FOR 1-1/2" METER CATALOG NUMBER	APPROX. WT. LBS.	HEIGHT	FOR 2" METER CATALOG NUMBER	APPROX. WT. LBS.
13"	VHH46-13B-NL	31.0	13"	VHH47-13B-NL	38.0
15"	VHH46-15B-NL	31.0	16"	VHH47-16B-NL	38.0
18"	VHH46-18B-NL	32.0	18"	VHH47-18B-NL	39.0
24"	VHH46-24B-NL	32.0	24"	VHH47-24B-NL	40.0
27"	VHH46-27B-NL	33.0	27"	VHH47-27B-NL	42.0

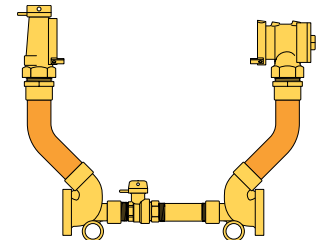

RESETTER WITH BY-PASS

FLANGED BALL VALVE ON INLET AND ANGLE CHECK VALVE OUTLET

HEIGHT	FOR 1-1/2" METER CATALOG NUMBER	APPROX. WT. LBS.	HEIGHT	FOR 2" METER CATALOG NUMBER	APPROX. WT. LBS.
14"	VBH46-14B-NL	30.0	14"	VBH47-14B-NL	39.0
16"	VBH46-16B-NL	30.0	16"	VBH47-16B-NL	39.0
18"	VBH46-18B-NL	30.0	18"	VBH47-18B-NL	39.0
24"	VBH46-24B-NL	31.0	24"	VBH47-24B-NL	41.0
27"	VBH46-27B-NL	31.0	27"	VBH47-27B-NL	42.0

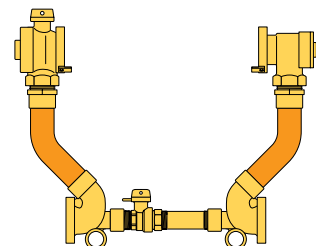

Reseters for 1-1/2" & 2" Flanged Meters

With By-Pass

Standard meter spacing for 1-1/2" and 2" reseters will be 13" and 17" respectively unless otherwise specified.

RESETTER WITH BY-PASS FLANGED BALL VALVE ON INLET AND ASSE APPROVED ANGLE DUAL CHECK VALVE OUTLET

HEIGHT	FOR 1-1/2" METER CATALOG NUMBER	APPROX. Wt. LBS.	HEIGHT	FOR 2" METER CATALOG NUMBER	APPROX. Wt. LBS.
14"	VBHH46-14B-NL	32.0	14"	VBHH47-14B-NL	40.0
16"	VBHH46-16B-NL	32.0	16"	VBHH47-16B-NL	40.0
18"	VBHH46-18B-NL	32.0	18"	VBHH47-18B-NL	40.0
24"	VBHH46-24B-NL	33.0	24"	VBHH47-24B-NL	42.0
27"	VBHH46-27B-NL	34.0	27"	VBHH47-27B-NL	43.0

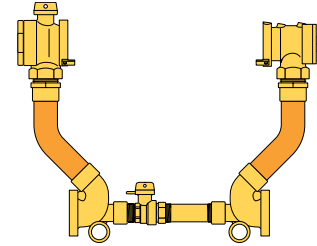

The Ford Tandem Reseters and Types A and B Reseters

Tandem Reseters can be used to install in series:

1. Two meters for comparing registration
2. A meter and a recording meter
3. A meter and a pressure or recording gauge
4. A meter and a pressure regulator

Tandem Reseters have a bottom bar equal in length and thread size to a given size of water meter. This permits easy connection with existing meter couplings or meter holding devices.

When a meter is to be installed in series with some device other than a second meter, it may be necessary to use extensions or adapters on the device to achieve the correct length and thread size to fit the Tandem Reseter. If necessary, special Tandem Reseters can be produced to specific dimensions.

Type A Tandem Resetter

(double end connection is included)



CATALOG NUMBER	METER SIZE
Resetter-1A-NL	5/8"
Resetter-2A-NL	5/8"x3/4"
Resetter-3A-NL	3/4"
Resetter-4A-NL	1"

The Type A Tandem Resetter places meters (or a meter and a second device) in a straight line. Special spacing of end connections can be manufactured upon request. The double end connection used between the meters is included with the Resetter.

Double End Connection Only

(for connecting meters)

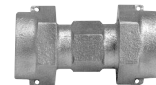

CATALOG NUMBER	METER SIZE
DEC-1-NL	5/8"
DEC-2-NL	5/8"x3/4" & 3/4"
*DEC-3-AWT-NL	1"

*Consists of two components assembled watertight.

Type B Tandem Resetter

The Type B Tandem Resetter places meters (or a meter and a second device) in a parallel position. It is satisfactory for shallow pit installations or for basement installations.



CATALOG NUMBER	METER SIZE
Resetter-1B-NL	5/8"
Resetter-2B-NL	5/8"x3/4"
Resetter-3B-NL	3/4"

Ford No-Rise Setter

for 1-1/2" and 2" Meters

Offered in many custom sizes, types and configurations, the Ford No-Rise Setter offers the same Ford quality as copper setters for in-line applications.

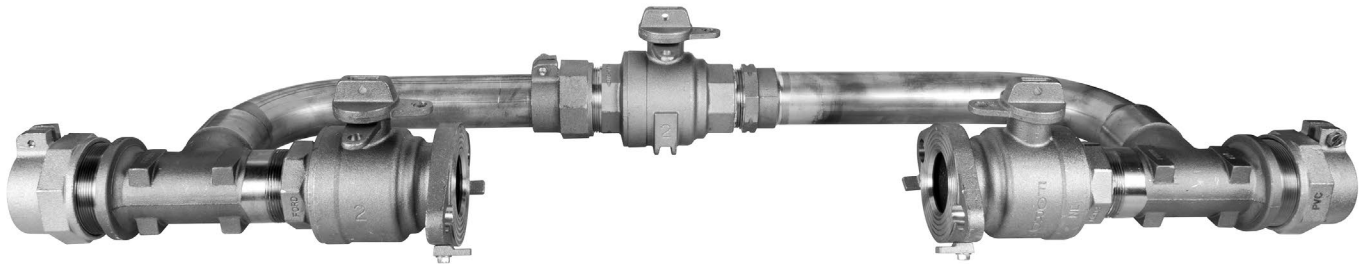

Contact factory for pricing and availability.

70 Series Style Setter

Type of meter inlet valve & outlet valve

- VBB = inlet ball valve & outlet ball valve
- VBH = inlet ball valve & outlet single check valve

80 Series Style Setter

Type of meter inlet valve & outlet valve

- *VV = inlet angle key valve & outlet angle key valve
- *VHH = inlet angle key valve & outlet angle dual check valve
- VBB = inlet angle ball valve & outlet angle ball valve
- VBH = inlet angle ball valve & outlet angle check valve

Ford No-Rise Coppersetter Numbering System

Service line connection type

- 1 = Female iron pipe
- 4 = Pack Joint for CTS (2" only)
- 7 = Pack Joint for PVC pipe (2" only)

Service line connection size

- 6 = 1-1/2"
- 7 = 2"

Style of Setter

- 7 = 70 series
- 8 = 80 series

Meter size

- 6 = 1-1/2" meter
- 7 = 2" meter

Inlet
Outlet

Inlet
Outlet

VBB77-00B-44-77-G-NL

Height

- 00 = no rise (70 series)
- 05 = 5" rise (80 series, 1-1/2")
- 06 = 6" rise (80 series, 2")

B = By-pass (Always)

BHH = By-pass with check valve

Options

-G = Grip Joint compression nut (2" only)

-NL = No Lead alloy

* VV86 and VHH86 will have a 6" rise.

Metering Manifolds

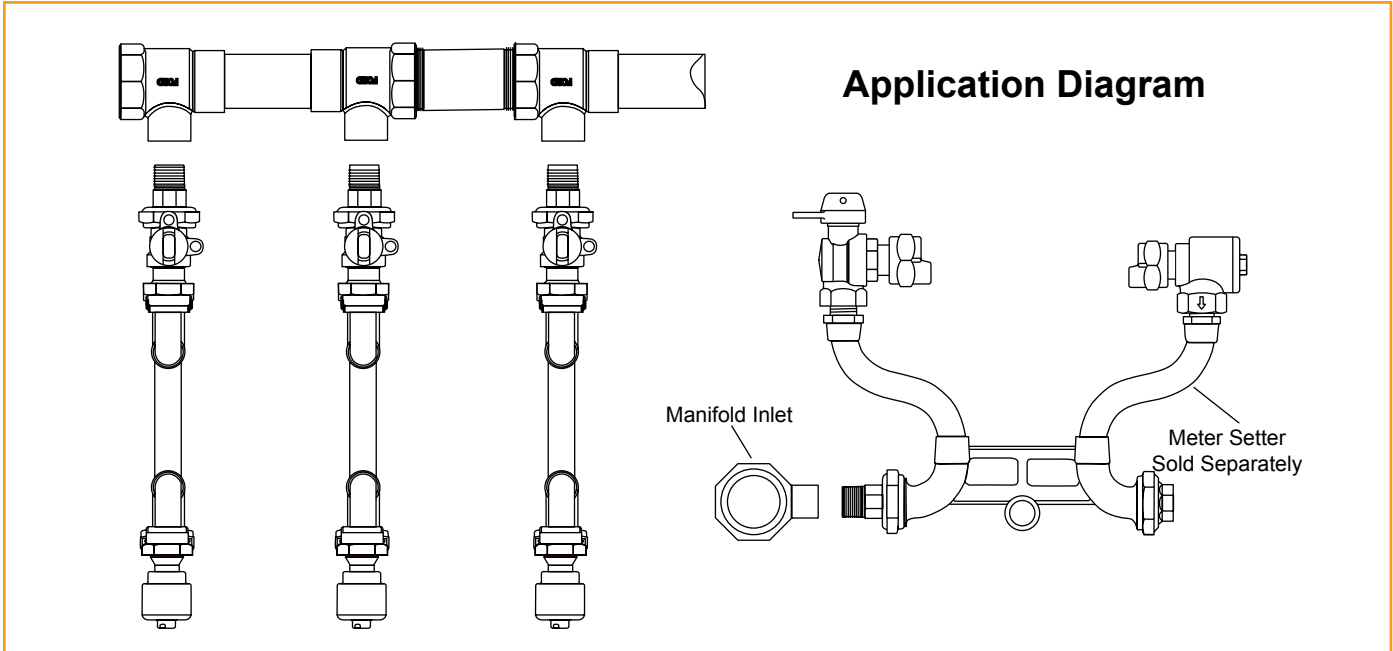
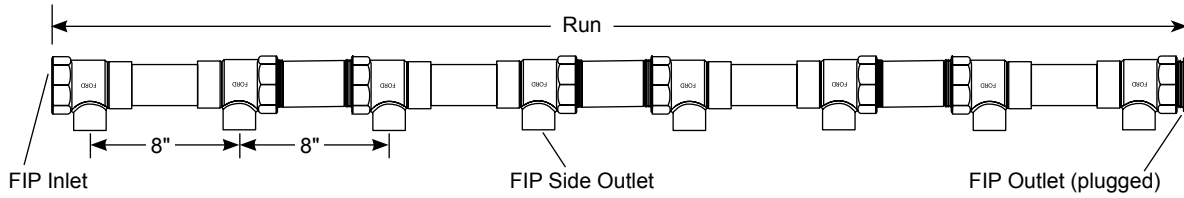

Used to install a series of meter setters in a central location, Ford Metering Manifolds offer uniform support for various styles and quantities of meter setters. Available with either a 1-1/2" or 2" diameter run, the side outlets have 1" female iron pipe threads for connecting meter setters with a 1" male iron pipe threaded swivel connection. Side outlets are spaced 8" on center as standard. The run outlet is plugged. Ford recommends attaching a valve (price book section G, ordered separately) to the manifold inlet. Meter setters are listed in this price book section F and must be ordered separately. (Shipped unassembled.)

NUMBER OF SIDE OUTLETS	FIP INLET, PLUGGED FIP OUTLET	FIP SIDE OUTLET SIZE	CATALOG NUMBER	APPROX. WT. LBS.
4	1-1/2"	1"	M111-464-NL	11.4
5	1-1/2"	1"	M111-564-NL	14.7
5	2"	1"	M111-574-NL	17.6
6	2"	1"	M111-674-NL	21.6
7	2"	1"	M111-774-NL	25.4
8	2"	1"	M111-874-NL	29.3

Manifold Number System

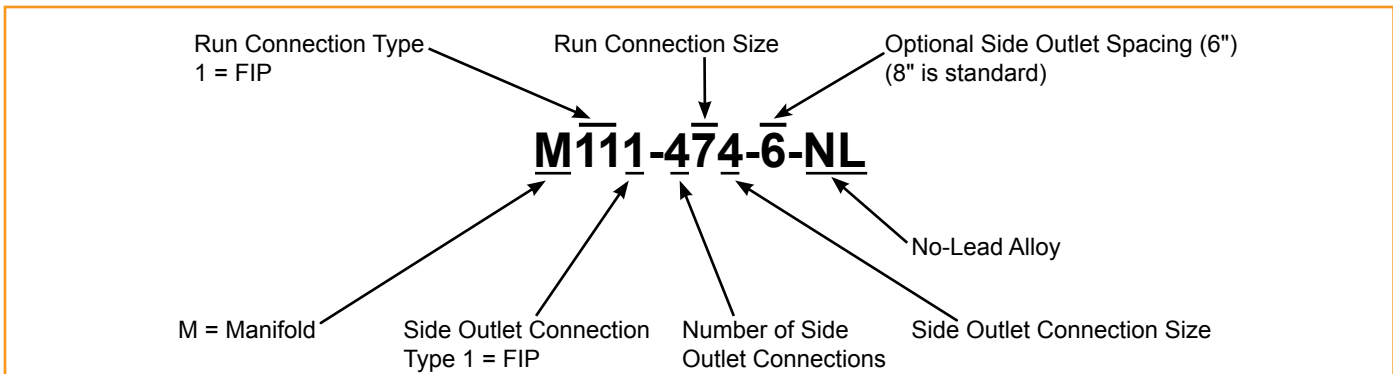

Section F

Ford® Coppersettters, Linesettters and Resettters

Warranty

All merchandise is warranted to be free from defects in material and factory workmanship for one year from date of shipment from our factory. We will provide, free of charge, new products in equal quantities for any that prove defective within one year from date of shipment from our factory. Manufacturer shall not be liable for any loss, damage, or injury, direct or consequential, arising out of the use of or the inability to use the product. Before using, user shall determine the suitability of the product for user's intended use and user assumes all risk and liability whatever in connection therewith. No claims for labor or consequential damage will be allowed. The foregoing may not be changed except by agreement signed by an officer of the manufacturer.

No other warranties are applicable or may be implied, including the implied warranty of merchantability and the implied warranty of fitness for particular purpose and any warranty relating to infringement or the like, all of which are disclaimed.

Please Note:

Consult the Ford Meter Box Company, Inc. website (www.fordmeterbox.com) for the most recent catalog information. The Ford Meter Box Company considers the information in this catalog to be correct at the time of publication. Items and option availability, including specifications, are subject to change without notice. Please verify that your product information is current.



36 Hudson Rd
Sudbury MA 01776



800-225-4616
www.tisales.com



The Ford Meter Box Company, Inc. 775 Manchester Avenue, P.O. Box 443, Wabash, Indiana, USA 46992
Telephone: 260.563.3171 • FAX: 1.800.826.3487 • Overseas FAX: 260.563.0167 • fordmeterbox.com