



36 Hudson Rd
Sudbury MA 01776



800-225-4616
www.tisales.com



THE FORD METER BOX COMPANY, INC.
CERTIFIED TO ISO 9001:2015
10002505

Section D

Ford® Meter Box Covers



Contents

	Page
Meter Box Numbering System	3
Meter Box Cover Installation.....	4
Ford Electronic Meter Read Covers	4
Ford Lifter Worm Locks.....	5
Pentagon Bolts	5
Ford Meter Box Cover and Valve Keys	5
Meter Pit Insulating Discs and Blankets	5
Ford Plastic AMR Plug	6
Ford Plastic ERT Bracket	6
Ford Wabash Double Lid Covers	7
Ford Type A Single Lid Covers	8
Ford Type C Single Lid Covers.....	9
Ford Type X Single Lid Covers.....	10
Ford PMBC-3 Plastic Meter Box Cover	10
Ford Extension Rings	11
Ford Elevator Rings	11
Ford Flat Meter Box Covers	12
Ford Monitor Covers for Large Settings	13
Ford Rectangular Meter Pit Covers	14
Ford Round Pit Ring and Lid	15
Special Spiked Covers	15
Ford Adjustable Cover	15
Warranty	16



Lids and frames are manufactured from cast iron meeting ASTM A48, Class 25 (25,000 PSI tensile strength).



Ford Meter Box Cover Numbering System

15" - 21" Meter Pit Covers

TYPE OF COVER

- 32B** = Adjustable Cover 11-1/2" Lid, 18" Pit Diameter
- A** = Inset Single Lid Cover (4" depth)
- A32C** = Spiked Cover 11-1/2" Lid, 18" Pit Diameter
- C** = Overlapping Single Lid Cover (4" depth)
- KA** = Flat Cover with Inset Lid
- PMBC** = Overlapping Single Lid Plastic Cover (4" depth)
- W** = Wabash Double Lid Cover (10" depth)
- X** = Overlapping Single Lid Hinged Cover (4" depth)

LID DETAILS

- A** = Aluminum Inner Lid with W3 Cover Instead of Plastic
- D** = Recessed Plastic Inner Lid for W Style Cover with 11-1/2" Lid Opening - Standard with Plastic Lids and Lids with E-read Holes
- H** = Extra Heavy Lid
- L** = Lid Only, without Frame. The "L" will need to appear with all Lid Only part numbers.
- P** = Locking Plastic Lid (11-1/2" size only)
- PR** = Plastic Inset Lid (11-1/2" size only) - only on W, A and KA style Lids
- HH** = Double Extra Heavy Frame with Extra Heavy Lid for Style A only

TYPE OF TOP LID OR FRAME

- C3** = Special Spiked & Adjustable Top Lid *Only*
- CX** = Type "C" or Type "X" Plastic Top Lid *Only*
- *F** = Frame Only
- WA** = Wabash, Type "A", Type "KA" Top Lid *Only*

A 3 2 H H - T

LID SIZE

(This code also represents the tile size when only one digit is listed, see tile size for code representation.)

- 1 = 8"
- 2 = 9-1/2"
- 3 = 11-1/2"
- 4 = 11-1/2" (except X43 has a 13-1/2" lid)
- 5 = 15"
- 6 = 18"
- 7 = 20"
- 8 = 21"

TILE SIZE

(If this number is not indicated, the lid size code number designates the tile size code number also)

- 1 = 15"
- 2 = 18"
- 3 = 20"
- 4 = 21"
- 1-4** = 15"-21" (adjustable cover with 11-1/2" lid only)

OPTIONS

- BR** = Plastic ERT Bracket (11-1/2" plastic lids and PPSC iron covers only)
- LB** = Large Pentagon Bolt
- LL** = Lockless Lid (iron lids only)
- T** = Single Electronic Meter Reading Lid, 2" Hole
- TT** = Double Electronic Meter Reading Lid, Two 2" Holes
- TP** = Single Electronic Meter Reading Lid, with Removable Plug
- TTP** = Double Electronic Meter Reading Lid, with Removable Plugs

* "F" placed before cover type code designates "Frame Only"

24" and Larger Meter Pit Covers

TYPE OF LID

- MC** = Monitor Covers
- RM** = Rectangular Meter Pit Covers for 2' x 3' Pits
- RML** = Monitor, Pit and Rectangular Top Lid *ONLY*

LID THICKNESS

- H** = Extra Heavy Lid
- HH** = Double Extra Heavy Lid

LID AND INNER LID

- MB** = Inner Lid
- P** = Plastic Lid (not available in extra heavy or double extra heavy)

MC - 2 4 H H - M B - T

FOR RECTANGULAR PIT COVERS

- 1 = Standard Lid
- 11 = Extra Heavy Lid
- 12 = Double Extra Heavy Lid
- 2 = Standard Lid with Inner Lid
- 21 = Extra Heavy Lid with Inner Lid
- 22 = Double Extra Heavy Lid with Inner Lid

FOR MONITOR COVERS

- 24 = 24" Pit Diameter
- 30 = 30" Pit Diameter
- 36 = 36" Pit Diameter

OPTIONS

- T** = Single Electronic Meter Reading Lid, 2" Hole
- TT** = Double Electronic Meter Reading Lid, Two 2" Holes
- LB** = Large Pentagon Bolt
- LL** = Lockless Lid

Note: See item listings in catalog section to ensure that desired sizes and options are available.

Meter Box Cover Installation, Maintenance and Safety

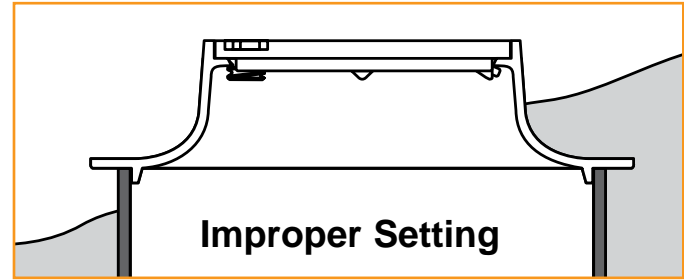
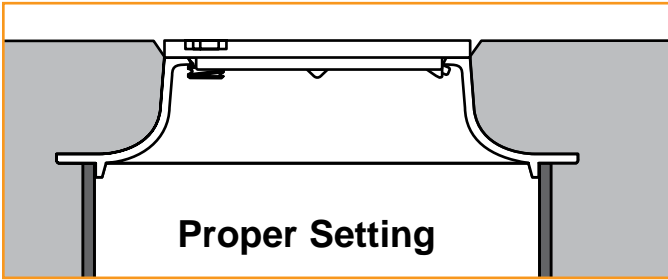

1. Make sure the cover, which consists of a frame and lid, fits securely onto the meter pit. Ford frames have positioning lugs extended from the bottom of the frame to prevent the cover from sliding off of the meter pit.
2. Backfill and compact around the frame to ensure the grade remains level with the top of the cover. This will help avoid a tripping hazard.
3. Install lid onto the cover frame and lock securely into place. Locking style lids are preferred to discourage unauthorized removal, which could cause a safety hazard. If a lockless style lid is specified, always make certain it is placed properly into the frame recess to prevent sliding or tipping out of position. Ford lockless lids have extra long positioning lugs to help ensure proper and safe lid placement.
4. Lids and frames are designed as a compatible unit and it is not a good practice to intermingle lids and frames from various manufacturers. The incompatibility of components from other manufacturers could result in field complications and injury. User assumes all risk of mixing Ford lids with another manufacturer's frame.
5. Check on a regular basis to ensure proper operation of locking devices and to make certain the meter cover lid remains secure and level with the surrounding surface. Replace damaged components immediately. Keep components free from debris to ensure the lid seats properly. Always make sure lids are seated and locked properly after every use to avoid injury.

Ford Electronic Meter Reading Covers

Special lids for a number of Ford cover styles are available with precast holes for remote electronic meter reading modules. These lids are especially configured for this purpose, and are manufactured so the electronic meter reading module will seat against a flat surface. Drilling a hole in a standard lid to accommodate an electronic meter reading module is not practical for many older lids, as the existing cover support ribs will interfere with the module flanges, and the drilled hole may seriously weaken the lid. Always use a special Ford lid when installing an electronic meter reading module.

To Order: For single hole electronic meter reading covers, add one catalog number suffix letter to the catalog number. For example, to add a single hole to a Wabash W32 Cover, for the installation of a single module, the catalog number would be **W32-T**. Add two T's for a double hole electronic meter reading cover, for example, **W32-TT**. See product listings in this catalog to ensure desired options are available.

A plastic inner lid with a 2" recess is standard (see page 7) in Wabash Style Electronic Meter Reading Covers with an 11-1/2" lid opening.

An optional cast iron plug, removable for future electronic meter reading module installations, is available for all electronic meter reading lids. This option is designated with a "-TP" for a single hole cover, or a "-TTP" for a double hole cover. A plastic plug is also available to improve transmission of AMR signals. See page 6.



Single Hole



Double Hole

Ford Lifter Worm Lock



All locking lids, except one-piece flat covers, feature a unique "worm" type lock. Two things happen as the key is turned and the lid is opened:

1. The hard cast iron worm rotates, applying a powerful screw-jack action between the lid and cover to break any seal of ice or dirt, **and**
2. The key attaches itself to the forged silicon bronze pentagon bolt, forming a lifter handle for the lid, then automatically disengages from the lid as the cover is locked.

Pentagon Bolts

Ford supplies pentagon bolts in two sizes. The small size, known as the standard waterworks pentagon, is used on all locking covers unless the larger size is specified. To order the large bolt, add "-LB" to the catalog number.

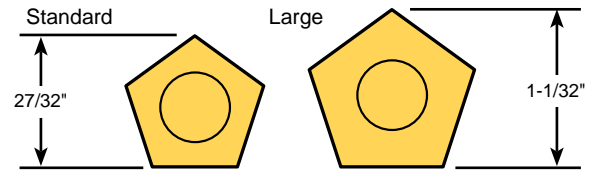

Ford Meter Box Cover and Valve Keys

All keys are cast steel with zinc plating or e-coating. They attach automatically to bolts of lifter worm locks for lifting the lid. Curb box keys for use with curb boxes are listed in the Ford Curb Box Catalog Section GA. **Note:** KEY-3 and KEY-4 valve keys will NOT work with 1" and 1-1/4" upper section curb boxes. See Catalog Section GA for curb box key (Key-CB).

Ford Meter Box Cover and Valve Keys

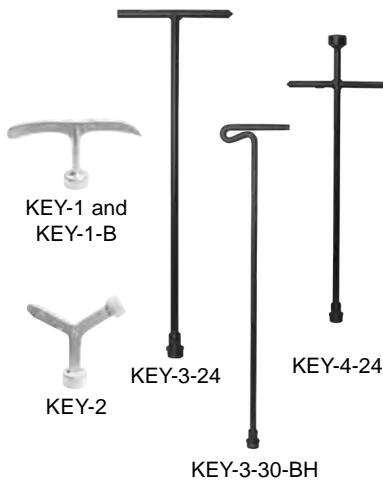

CATALOG NUMBER	DESCRIPTION
KEY-1	Key for Standard Pentagon
KEY-1-B	Key for Large Pentagon
KEY-1-S	Key for Standard Pentagon, Slotted for Valve Tee Head
KEY-2	Key for Standard and Large Pentagon
KEY-2-S	Key for Standard and Large Pentagon, Slotted for Valve Tee Head
KEY-3-24	24" Long Key for Standard Pentagon
*KEY-3-B-24	24" Long Key for Large Pentagon
KEY-3-30-BH	30" Long Key for Standard Pentagon, Bent Handle
KEY-3-36	36" Long Key for Standard Pentagon
KEY-3-48	48" Long Key for Standard Pentagon
KEY-3-60	60" Long Key for Standard Pentagon
KEY-3-72	72" Long Key for Standard Pentagon
KEY-4-24	24" Long Key for Standard Pentagon on One End and Large Pentagon on Other Tee End
KEY-4-36	36" Long Key for Standard Pentagon on One End and Large Pentagon on Other Tee End
KEY-4-48	48" Long Key for Standard Pentagon on One End and Large Pentagon on Other Tee End

Contact factory for availability on lengths not listed.

Note: Number 3 and 4 keys for the standard pentagon bolt are slotted for valve operation.

* Keys for large pentagon bolts are not slotted for valve operation. Add "-SLOTTED" to catalog number, if needed.

Closed-Cell Insulating Discs

Insulating discs provide extra protection against meter freeze-ups. Ford Insulating Discs are made from closed-cell polyethylene foam. A tie strap handle is furnished to assist in removal. For removal purposes, insulating discs 2" and thicker are recommended for flat lids having the same diameter or larger.

CATALOG NUMBER	METER PIT DIAMETER	THICKNESS	MINIMUM R-VALUE	COLOR
CCID-15	15"	1-1/2"	6.0	Gray
CCID-15-2		2"	4.0	Green or White
CCID-15-4		4"	8.0	Green or White
CCID-15-6		6"	12.0	Green or White
CCID-18	18"	1-1/2"	6.0	Gray
CCID-18-2		2"	4.0	Green or White
CCID-18-4		4"	8.0	Green or White
CCID-18-6		6"	12.0	Green or White
CCID-20	20"	1-1/2"	6.0	Gray
CCID-24	24"	1-1/2"	6.0	Gray
CCID-36-2-2 ■	36"	2"	4.0	Green or White
CCID-36-4-2 ■		4"	8.0	Green or White

■ Two-piece with removable center access plug for viewing the meter register.

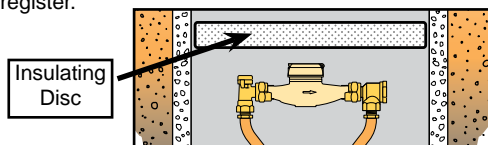

Meter Pit Insulating Blanket - FIB

The Ford Insulating Blanket, made of Minicel cross-linked polyethylene, was designed to drape over the meter setting within a meter pit. The effective and inexpensive insulating blanket traps heat from the base of the meter pit, concentrating the heat around the meter to help prevent meter freeze-ups.

CATALOG NUMBER	DIMENSION	THICKNESS
FIB	4' x 4'	3/32"

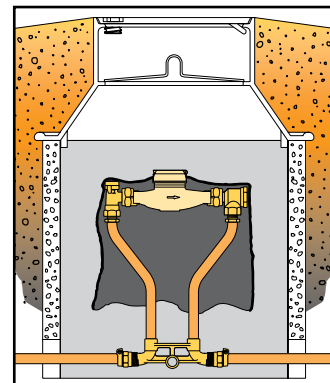

Plastic AMR Plug **PTP or PTP-BR** U.S. Patent No. 8,350,719

The plastic AMR plug permits radio transmission to easily travel through the plug. It also prevents rodents, reptiles or debris from entering into the pit through an existing 1-27/32" or 2" AMR hole. The AMR plug with bracket (PTP-BR) is the perfect solution for utilities with EMT programs. Simply assemble the threaded plastic plug and ERT bracket within an existing AMR hole of a meter box/pit lid. Insert ERT head into bracket and you're ready for transmission.

- Black polypropylene based
- Radio transmissions are easily transferred through the plug
- ERT bracket accommodates most ERT head types

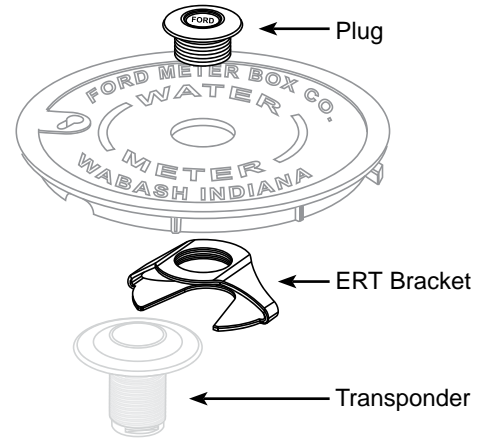
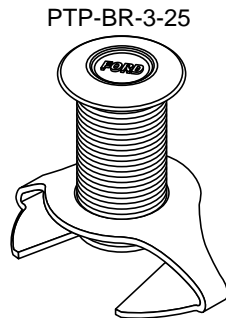
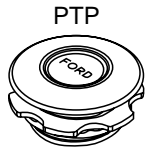

Plastic AMR Plug

CATALOG NO.	DESCRIPTION	APPROX. WT. LBS.
PTP	Removable Plastic Plug/Nut for Electronic Meter Reading Lid Hole (1-27/32" - 2" diameter hole) for Lids having a Maximum Hole Thickness of 5/8"	0.06
PTP-BR	Removable Plastic Plug for Electronic Meter Reading Lid Hole (1-27/32" - 2" diameter hole) with ERT Bracket for Lids having a Maximum Hole Thickness of 5/8"	0.10
PTP-3-25	Removable Plastic Plug/Nut for Electronic Meter Reading Lid Hole (1-27/32" - 2" diameter hole) for Lids having a Thickness Range of 1/8" to 3-1/4"	0.10
* PTP-BR-3-25	Removable Plastic Plug for Electronic Meter Reading Lid Hole (1-27/32" - 2" diameter hole) with ERT Bracket for Lids having a Thickness Range of 1/8" to 3-1/4"	0.14

* May require two plastic nuts depending on lid thickness. One nut to secure plug to the lid and the other to maintain bracket placement. (See middle illustration below.)

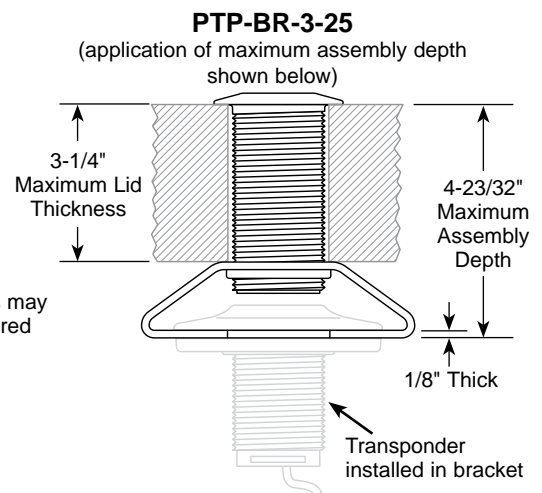
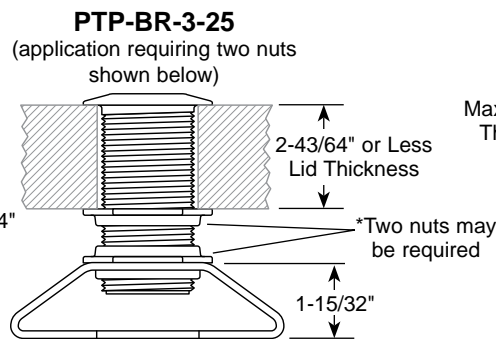
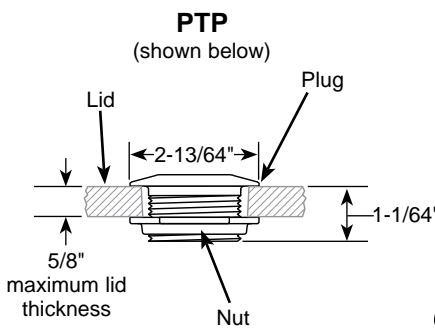

Plastic AMR Plug Components

CATALOG No.	DESCRIPTION	APPROX. WT. LBS.
PLUG-300355	Plastic Lid Plug Only with 1" Threaded Post	0.04
PLUG-300354	Plastic Lid Plug Only with 3-1/2" Threaded Post	0.08
NUT-300356	Plastic Nut	0.02
BRACKET-300351	Plastic ERT Bracket	0.06

ERT Bracket

Optional ERT Bracket for Plastic Lids

The plastic ERT bracket is ultrasonically installed at the factory when ordered with a plastic lid. To order lids with the ERT bracket, add "-BR" to the end of the catalog number.

The ERT bracket may be field installed to any Ford Meter Box plastic lid having the three bracket posts on the underside of the lid by using three stainless steel clip rings. (catalog number: PBR-YJ)

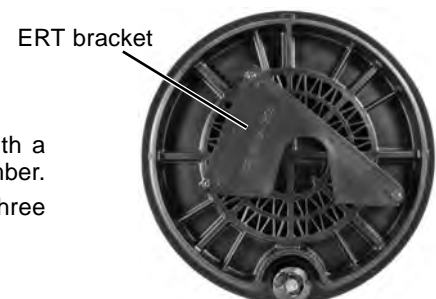

Ford Wabash Double Lid Covers



The inner lid provides greater frost protection for meters. Extra depth, sloping skirt, and a 4" dead air space combine to reduce heat loss. An optional W3BPD plastic recessed inner lid, for the 11-1/2" size only, is available to accommodate taller electronic meter reading modules. The W3BPD is standard when ordering Wabash Covers with the electronic meter reading lid, single or double hole. All of the double lid covers with iron top lids have inset lids, which enhance lid stability and allows flush installations with a lawn or cement surface. An optional plastic top lid is available to allow better radio frequency travel. Lifter worm lock has standard size pentagon bolt unless larger size is specified. Inner lids are plastic in 11-1/2" size only; aluminum is optional. WA3L iron lid is available with the word "SEWER" marked on it at no extra charge.

Iron Wabash Double Lid Covers with (inset) Iron Lid

COVER WITH LOCKING IRON LID	COVER WITH LOCKLESS IRON LID	COVER WITH LOCKING ELECTRONIC METER READING IRON LID (2" HOLE)		LID SIZE*	TILE SIZE I.D.	APPROX. WT. LBS.
		CATALOG NUMBER				
		SINGLE HOLE LID	DOUBLE HOLE LID			
W1	-	-	-	8"	15"	34.0
W31	W31-LL	**W31-T	**W31-TT	11-1/2"	15"	45.0
W2	-	W2-T	-	9-1/2"	18"	42.0
W32	W32-LL	**W32-T	**W32-TT	11-1/2"	18"	50.0
W3	W3-LL	**W3-T	**W3-TT	11-1/2"	20"	55.0
W4	W4-LL	**W4-T	**W4-TT	11-1/2"	21"	56.0
COVER WITH EXTRA HEAVY FRAME AND EXTRA HEAVY LID						
W3H	-	**W3H-T	-	11-1/2"	20"	89.0

Iron Wabash Covers with Plastic Lid

COVER WITH INSET LOCKING PLASTIC LID	LID SIZE*	TILE SIZE I.D.	APPROX. WT. LBS.
**♦ W31PR	11-1/2"	15"	32.0
**♦ W32PR	11-1/2"	18"	39.0
**♦ W3PR	11-1/2"	20"	40.0
**♦ W4PR	11-1/2"	21"	40.0

To order covers (11-1/2" lid size only) with optional plastic 2" recessed inner lid, add "-D" to the catalog number. Example: W3-D
 ** The plastic 2" recessed inner lid (W3BPD) is standard when ordering 11-1/2" lid size covers with an electronic meter reading lid and Wabash covers with plastic inset lids.

Lids Only for Wabash Covers

LID SIZE*	CATALOG NUMBER				APPROX. WT. LBS.
	LOCKING LID	LOCKLESS LID	LOCKING ELECTRONIC METER READING IRON LID (2" HOLE)		
			SINGLE HOLE LID	DOUBLE HOLE LID	
8" Iron	WA1L	-	WA1L-T	-	5.0
9-1/2" Iron	WA2L	-	WA2L-T	-	6.5
11-1/2" Iron	WA3L	WA3L-LL	WA3L-T	WA3L-TT	9.5
11-1/2" Extra Heavy Iron	WA3LH	-	WA3LH-T	-	22.0
LOCKING PLASTIC LID SIZE*					
11-1/2" Plastic (Inset)	♦ WA3LPR	-	WA3LPR-C-T	-	3.1

Inner Lids Only for Wabash Covers



W3BPD Plastic Inner Lid



Aluminum Inner Lid



Plastic Inner Lid

CATALOG NUMBER	SIZE	MATERIAL	APPROX. WT. LBS.
W1BA	8"	Aluminum	0.9
W2BA	9-1/2"	Aluminum	1.0
W3BA	11-1/2"	Aluminum	1.7
W3BP	11-1/2"	Plastic	0.6
** W3BPD	11-1/2"	Plastic with 2" Recess	0.6

*Lid size indicates approximate pit access opening; actual lid diameter is approximately 1" larger.

** Standard when ordering Wabash covers with an 11-1/2" electronic meter reading lid and Wabash covers with plastic inset lids.

♦ Add "-BR" to end of catalog number for factory assembled ERT bracket.

NOTE: Locking lids are supplied with a standard pentagon bolt. For an optional large bolt, add "-LB" to the catalog number. For example, a W3-LB is a W3 cover with a large bolt on the locking lid.

Ford Type A Single Lid Covers



Inset lids enhance lid stability and allow flush installations with the surface of the sidewalk or lawn. These cast iron covers are 4" in depth and include the lifter worm lock with a standard pentagon bolt unless a larger bolt is specified. An optional plastic top lid is available to allow better radio frequency travel. WA3L iron lid is available marked "SEWER" at no extra charge.

Type A Single Lid Iron Covers with (inset) Iron Lid

CATALOG NUMBER				LID SIZE*	TILE SIZE I.D.	APPROX. WT. LBS.
COVER WITH LOCKING IRON LID	COVER WITH LOCKLESS IRON LID	COVER WITH LOCKING ELECTRONIC METER READING IRON LID (2" HOLE)				
		SINGLE HOLE LID	DOUBLE HOLE LID			
A1	—	—	—	8"	15"	27.0
A31	A31-LL	A31-T	A31-TT	11-1/2"	15"	28.0
A2	—	A2-T	—	9-1/2"	18"	30.0
A32	A32-LL	A32-T	A32-TT	11-1/2"	18"	32.0
A3	A3-LL	A3-T	A3-TT	11-1/2"	20"	37.0
A4	A4-LL	A4-T	A4-TT	11-1/2"	21"	40.0
A53	—	A53-T	A53-TT	15"	20"	43.0
COVER WITH EXTRA HEAVY FRAME AND EXTRA HEAVY LID						
A3H	—	A3H-T	—	11-1/2"	20"	54.0
COVER WITH DOUBLE EXTRA HEAVY FRAME AND EXTRA HEAVY LID						
A32HH	—	A32HH-T	—	11-1/2"	18"	64.0

Type A Iron Covers with (inset) Plastic Lid

CATALOG NUMBER	LID SIZE*	TILE SIZE I.D.	APPROX. WT. LBS.
COVER WITH INSET LOCKING PLASTIC LID			
♦ A31PR	11-1/2"	15"	21.0
♦ A32PR	11-1/2"	18"	25.0
♦ A3PR	11-1/2"	20"	30.0
♦ A4PR	11-1/2"	21"	24.0

Lids Only for Type A Covers

LID SIZE*	LOCKING LID	CATALOG NUMBER			APPROX. WT. LBS.
		LOCKLESS LID	LOCKING ELECTRONIC METER READING IRON LID (2" HOLE)		
			SINGLE HOLE LID	DOUBLE HOLE LID	
8" Iron	WA1L	—	WA1L-T	—	5.0
9-1/2" Iron	WA2L	—	WA2L-T	—	6.5
11-1/2" Iron	WA3L	WA3L-LL	WA3L-T	WA3L-TT	9.5
11-1/2" Extra Heavy Iron	WA3LH	—	WA3LH-T	WA3LH-TT	22.0
15" Iron	WA5L	—	WA5L-T	WA5L-TT	17.2
15" Extra Heavy Iron	WA5LH	—	WA5LH-T	WA5LH-TT	35.3
LOCKING PLASTIC LID SIZE*					
11-1/2" Plastic (Inset)	♦ WA3LPR	—	WA3LPR-C-T	—	3.1

♦ Add "-BR" to end of catalog number for factory assembled ERT bracket.

* Lid size indicates approximate pit access opening; actual lid diameter is approximately 1" larger.

NOTE: Locking lids are supplied with a standard pentagon bolt. For an optional large bolt, add "-LB" to the catalog number. For example, an A3-LB is an A3 cover with a large bolt on the locking lid.

Ford Type C Single Lid Covers



Overlapping style lid is primarily for installation in lawns. Locking lids have a standard pentagon bolt unless a larger size bolt is specified when ordering. Numbers C31, C32, C3 and C4 can be furnished with lids marked "GAS" at no extra charge. Other special lid markings are available. Contact your Ford Field Service Representative for details.

Type C Single Lid Iron Covers with Iron Overlapping Lid

CATALOG NUMBER				LID SIZE*	TILE SIZE I.D.	APPROX. WT. LBS.
COVER WITH LOCKING LID	COVER WITH LOCKLESS LID	COVER WITH LOCKING ELECTRONIC METER READING LID (2" HOLE)				
		SINGLE HOLE LID	DOUBLE HOLE LID			
C1	–	C1-T	–	8"	15"	21.0
C21	–	–	–	9-1/2"	15"	25.0
C31	C31-LL	C31-T	C31-TT	11-1/2"	15"	24.0
C32	C32-LL	C32-T	C32-TT	11-1/2"	18"	29.0
C52	–	C52-T	C52-TT	15"	18"	39.0
C3	C3-LL	C3-T	C3-TT	11-1/2"	20"	34.0
C53	–	C53-T	C53-TT	15"	20"	41.0
C4	C4-LL	C4-T	C4-TT	11-1/2"	21"	40.0
COVER WITH EXTRA HEAVY FRAME AND EXTRA HEAVY LID						
C31H	–	C31H-T	–	11-1/2"	15"	38.0
C32H	–	C32H-T	–	11-1/2"	18"	46.0
C3H	–	C3H-T	–	11-1/2"	20"	52.0

Type C Iron Covers with Overlapping Plastic Lid

CATALOG NUMBER				LID SIZE*	TILE SIZE I.D.	APPROX. WT. LBS.
COVER WITH OVERLAPPING LOCKING PLASTIC LID						
♦ C31P				11-1/2"	15"	17.0
♦ C32P				11-1/2"	18"	21.0
♦ C3P				11-1/2"	20"	25.0
♦ C4P				11-1/2"	21"	30.0

Lids Only for Type C Covers

LID SIZE*	CATALOG NUMBER				APPROX. WT. LBS.
	LOCKING LID	LOCKLESS LID	LOCKING ELECTRONIC METER READING IRON LID (2" HOLE)		
			SINGLE HOLE LID	DOUBLE HOLE LID	
8"	C1L	–	C1L-T	–	5.0
9-1/2"	C2L	–	–	–	8.0
11-1/2"	C3L	C3L-LL	C3L-T	C3L-TT	10.0
11-1/2" Extra Heavy	C3LH	–	C3LH-T	–	17.0
15"	C5L	–	C5L-T	C5L-TT	21.0
LOCKING PLASTIC LID SIZE*					
11-1/2" (Overlapping)	♦ CX3LP	–	–	–	2.6



CX3LP
11-1/2" Plastic Locking Lid Only



ERT bracket
CX3LP-BR
11-1/2" Plastic Locking Lid with ERT Bracket on Underside

♦ Add "-BR" to end of catalog number for factory assembled ERT bracket.

* Lid size indicates approximate pit access opening; actual lid diameter is approximately 1" larger.

NOTE: Locking lids are supplied with a standard pentagon bolt. For an optional large bolt, add "-LB" to the catalog number. For example, a C3-LB is a C3 cover with a large bolt on the locking lid.

Ford Type X Single Lid Covers

Overlapping style lid (as Type C Covers) but with a specially designed hinge to support the lid when open. The lid is removable. All lids are locking type only, and have standard size pentagon bolts unless larger size bolt is specified. All Type X lids can be marked "GAS" at no extra charge.



Type X Single Lid Iron Covers

COVER WITH LOCKING LID	CATALOG NUMBER		LID SIZE*	TILE SIZE I.D.	APPROX. WT. LBS.
	COVER WITH LOCKING ELECTRONIC METER READING LID (2" HOLE)				
	SINGLE HOLE LID	DOUBLE HOLE LID			
-	-	X31-TT	11-1/2"	15"	25.0
X32	X32-T	X32-TT	11-1/2"	18"	29.0
X3	X3-T	X3-TT	11-1/2"	20"	35.0
X43	X43-T	X43-TT	13-1/2"	20"	39.0
X4	X4-T	X4-TT	11-1/2"	21"	41.0

Type X Iron Covers with Plastic Lid

COVER WITH OVERLAPPING LOCKING PLASTIC LID	CATALOG NUMBER	LID SIZE*	TILE SIZE I.D.	APPROX. WT. LBS.
	COVER WITH			
	LOCKING			
◆X32P	11-1/2"	18"	21.0	
◆X3P	11-1/2"	20"	25.0	
◆X4P	11-1/2"	21"	30.0	

Lids Only for Type X Covers

LID SIZE*	CATALOG NUMBER			APPROX. WT. LBS.
	LOCKING LID	LOCKING ELECTRONIC METER READING IRON LID (2" HOLE)		
		SINGLE HOLE LID	DOUBLE HOLE LID	
11-1/2"	X3L	X3L-T	X3L-TT	10.5
13-1/2"	X43L	X43L-T	X43L-TT	10.5
PLASTIC LID SIZE*				
11-1/2" (Overlapping)	◆ CX3LP	-	-	2.6

◆ Add "-BR" to the end of the catalog number for factory assembled ERT bracket (see photo on page D-9).

* Lid size indicates approximate pit access opening; actual lid diameter is approximately 1" larger.

Note: Locking lids are supplied with a standard pentagon bolt. For an optional large bolt, add "-LB" to the catalog number. For example, an X3-LB is an X3 cover with a large bolt on the locking lid.

Ford PMBC-3 Plastic Meter Box Cover



PMBC-3

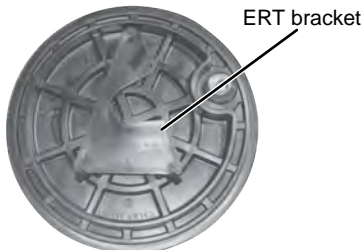

PMBC-3L-BR
(Lid only with ERT bracket on underside)

The Ford PMBC-3 plastic meter box cover is an economical alternative to iron covers. Its light weight means reduced shipping costs and easier installation. Constructed of high strength polypropylene, which resists chemical attack and the weakening effect of ultraviolet light, the PMBC-3 fits both 18" and 20" meter pits. Plastic is an excellent insulator; the PMBC-3 provides superior protection against meter pit freeze-ups in all but the harshest climates.

PMBC-3 Plastic Meter Box Cover

CATALOG NUMBER						
COVER/LID/ STANDARD BOLT	COVER/LID/ LARGE BOLT	COVER/LID/ ERT BRACKET	COVER/LID/ LARGE BOLT/ERT BRACKET	LOCKING LID SIZE*	TILE SIZE I.D.	APPROX. WT. LBS.
PMBC-3	PMBC-3-LB	PMBC-3-BR	PMBC-3-LB-BR	11"	18" and 20"	8.0

NOTE: Not available with Lockless Lid or AMR hole.

Lid Only for PMBC-3 Cover

CATALOG NUMBER					
LID SIZE*	LOCKING LID/ STANDARD BOLT	LOCKING LID/ LARGE BOLT	LOCKING LID/ ERT BRACKET	LOCKING LID/LARGE BOLT/ ERT BRACKET	APPROX. WT. LBS.
11"	PMBC-3L	PMBC-3L-LB	PMBC-3L-BR	PMBC-3L-LB-BR	3.5

Extension Rings

For Wabash, A, C, or X Covers



EXT-3

Extension Rings adapt 18" and 20" covers to fit 24", 30" or 36" meter pits.

Iron Extension Rings

CATALOG NUMBER	EXTENSION RING SIZE	APPROX. Wt. LBS.
EXT-1	Adapts 18" covers to 24" tile	24.0
EXT-2	Adapts 20" covers to 24" tile	21.0
EXT-3	Adapts 18" covers to 30" tile	49.0
EXT-4	Adapts 20" covers to 30" tile	48.0
EXT-5	Adapts 20" covers to 36" tile	105.0

Elevator Rings



ER15CX and ER3CX
Rings for Types C and
X Covers

Elevator rings raise 11-1/2" diameter lids of Types A, C and X single lid covers and Wabash double lid covers. The ring for Types C and X covers is attached by three bronze hooks which are included. The ring for Types A and Wabash covers is held in place by integral cast lugs with locking bolts. In all cases, the lid from the cover fits the ring. Elevator rings may be stacked for a desired height. Examples include an ER15CX and an ER3CX have a combined height of 4-1/2"; an ER25AW and an ER4AW have a 6-1/2" combined height.



ER25AW and ER4AW
Rings for Types A and
Wabash Covers

Iron Elevator Rings

CATALOG NUMBER	HEIGHT	STYLE COVERS	APPROX. Wt. LBS.
ER15CX	1-1/2"	C and X	7.0
ER3CX	3"	C and X	9.0
ER25AW	2-1/2"	A and Wabash	9.0
ER4AW	4"	A and Wabash	12.0

Ford Flat Meter Box Covers

Ford Flat Meter Box Covers are designed for shallow settings, where the insulation properties of a "hat shaped" design are not necessary. These covers offer the protection of sturdy cast iron construction at an economical price.

Flat Iron Covers with Iron Lids

CATALOG NUMBER				LID SIZE*	TILE SIZE I.D.	APPROX. WT. LBS.
COVER WITH LOCKING LID	COVER WITH LOCKLESS LID	COVER WITH LOCKING ELECTRONIC METER READING LID (2" HOLE)				
		SINGLE HOLE LID	DOUBLE HOLE LID			
KA31	KA31-LL	KA31-T	KA31-TT	11-1/2"	15"	31.0
KA32	KA32-LL	KA32-T	KA32-TT	11-1/2"	18"	37.0

Flat Iron Covers with Plastic Lids

CATALOG NUMBER		LID SIZE*	TILE SIZE I.D.	APPROX. WT. LBS.
COVER WITH PLASTIC LOCKING LID	COVER WITH PLASTIC LOCKING LID WITH ERT BRACKET			
KA31PR	KA31PR-BR	11-1/2"	15"	25.0
KA32PR	KA32PR-BR	11-1/2"	18"	31.0

Iron Lid Only for Flat Covers

LID SIZE*	CATALOG NUMBER				APPROX. WT. LBS.
	LOCKING LID	LOCKLESS LID	LOCKING ELECTRONIC METER READING LID (2" HOLE)		
			SINGLE HOLE LID	DOUBLE HOLE LID	
11-1/2"	WA3L	WA3L-LL	WA3L-T	WA3L-TT	9.5



Plastic Lid Only for Flat Covers

LID SIZE*	CATALOG NUMBER		APPROX. WT. LBS.
	LOCKING LID	LOCKING LID WITH ERT BRACKET	
11-1/2"	WA3LPR	WA3LPR-BR	3.1

OPTIONS: Large bolt is available, add "LB" to the catalog number. Example: WA3LPR-LB
 * Lid Size indicates approximate pit access opening; actual lid diameter is approximately 1" larger.



Iron Locking Lid



Composite H-20 Lid

One-Piece Iron Flat Covers (no separate lid)

TILE SIZE ID	CATALOG NUMBER							APPROX. WT. LBS.
	LOCKING COVER	LOCKLESS COVER	LOCKING COVER WITH ELECTRONIC METER READING LID (2" HOLE)		LOCKLESS COVER WITH ELECTRONIC METER READING LID (2" HOLE)			
			SINGLE HOLE	DOUBLE HOLE	SINGLE HOLE	RECESSED SINGLE HOLE	DOUBLE HOLE	
15"	◆ PPSC-15-L	PPSC-15	◆ PPSC-15-L-T	◆ PPSC-15-L-TT	PPSC-15-T	■ PPSC-15-REC-T	PPSC-15-TT	13.0
18"	◆ PPSC-18-L	PPSC-18	◆ PPSC-18-L-T	◆ PPSC-18-L-TT	PPSC-18-T	-	PPSC-18-TT	15.0

- ◆ Add "BR" to end of catalog number for factory assembled ERT bracket. (ERT bracket not available with a recessed e-read hole.)
- Extra heavy option available - use PPSCH-15-REC-T

H-20 Rated Composite Flat Covers (no separate lid)

TILE SIZE ID	CATALOG NUMBER		APPROX. WT. LBS.
	LOCKING COVER	LOCKING COVER W/ PLASTIC ERT BRACKET	
15"	PPSC-15-L-P	PPSC-15-L-P-BR	18.5
18"	PPSC-18-L-P	PPSC-18-L-P-BR	27.0

Ford Monitor Covers

For Large Settings

Monitor covers are designed for use on large tiles where a large lid opening is desired. They are satisfactory for 1-1/2" and 2" meters, or for two or more smaller meters. Each monitor cover consists of a flange casting to fit on the tile, a ring which is centered in place on the flange by a circular bead, and a top lid with a lifter worm lock. An optional inner lid provides added protection against frost damage in cold climates. The monitor cover is not designed to withstand traffic, but heavier lids are available for driveway installations where only lightweight traffic is likely.



Iron Monitor Covers for Large Settings with Iron or Plastic Lids

CATALOG NUMBER				LID SIZE* (DEPTH)	TILE SIZE I.D.	APPROX. WT. LBS.
◇ COVER WITH LOCKING LID	COVER WITH LOCKLESS LID	COVER WITH LOCKING ELECTRONIC METER READING LID (2" HOLE)				
		SINGLE HOLE LID	DOUBLE HOLE LID			
MC-24	MC-24-LL	MC-24-T	MC-24-TT	20" (7-1/2")	24"	103.0
MC-30	MC-30-LL	MC-30-T	MC-30-TT	20" (7-1/2")	30"	131.0
MC-36	MC-36-LL	MC-36-T	MC-36-TT	20" (8")	36"	185.0
WITH PLASTIC INNER LIDS						
MC-24-MB	MC-24-MB-LL	MC-24-MB-T	MC-24-MB-TT	20" (7-1/2")	24"	103.4
MC-30-MB	MC-30-MB-LL	MC-30-MB-T	MC-30-MB-TT	20" (7-1/2")	30"	141.4
MC-36-MB	MC-36-MB-LL	MC-36-MB-T	MC-36-MB-TT	20" (8")	36"	205.4

◇ Add "-P" for optional plastic lid. Example: MC-36-P

Lids Only for Monitor, Pit and Rectangular Covers

LID SIZE*	CATALOG NUMBER				APPROX. WT. LBS.
	LOCKING LID	LOCKLESS LID	LOCKING ELECTRONIC METER READING LID (2" HOLE)		
			SINGLE HOLE LID	DOUBLE HOLE LID	
20"	RML-1	RML-1-LL	RML-1-T	RML-1-TT	32.0
20" Extra Heavy	RML-11	-	RML-11-T	RML-11-TT	56.0
20" Double Extra Heavy	RML-12	-	RML-12-T	-	65.0
PLASTIC LIDS					
20"	RMLP-1	-	-	-	23.0

Parts for Monitor Covers

CATALOG NUMBER	DESCRIPTION	APPROX. WT. LBS.
MB	Plastic Inner Lid (optional)	2.1
PR	Ring (with lid recess) 6" Height	50.0
FL-24	Flange for 24" I.D. tile	22.0
FL-30	Flange for 30" I.D. tile	49.0
FL-36	Flange for 36" I.D. tile	105.0
PRR-2	2" Riser Ring for Monitor Cover Includes Hook and Nut Hardware	20.0

NOTE: Locking lids are supplied with a standard pentagon bolt. For an optional large bolt, add "-LB" to the catalog number. For example, a MC-30-LB is a MC-30 cover with a large bolt on the locking lid.

* Lid size indicates approximate pit access opening; actual lid diameter is approximately 1" larger.

Ford Rectangular Meter Pit Covers

The rectangular pit cover consists of a heavy frame to fit a meter pit 2' x 3', a ring mounted on the frame, a 20" top lid and an optional inner lid. The assembled cover depth is 9". The rectangular pit cover is sturdy but is not recommended to withstand vehicular traffic. Extra heavy and double extra heavy top lids are optional for use under light driveway traffic.

One or two extension plates, 2' x 3', will cover pits measuring 3' x 4' or 3' x 6'. The walls of such pits can be precast concrete, poured on the job, or laid up of bricks or blocks.

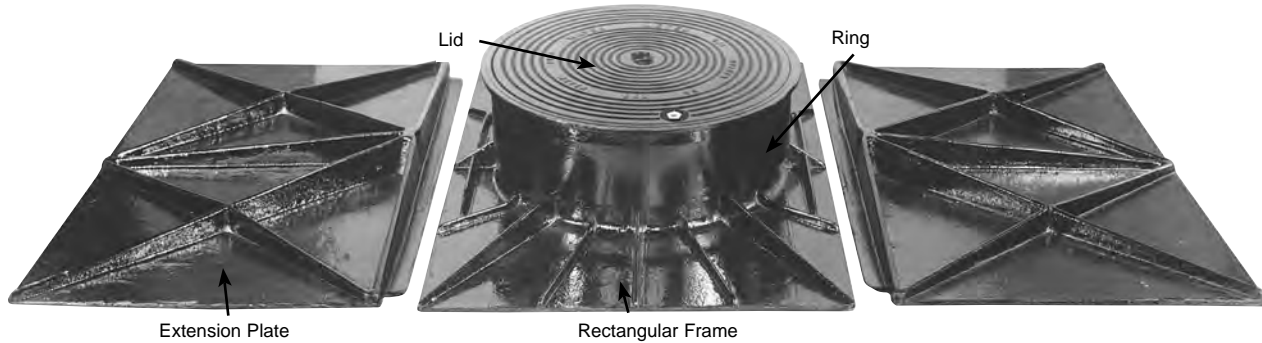

Iron Rectangular Meter Pit Covers

CATALOG NUMBER				APPROX. WT. LBS.
COVER WITH LOCKING LID	COVER WITH LOCKLESS LID	COVER WITH LOCKING ELECTRONIC METER READING LID (2" HOLE)		
		SINGLE HOLE LID	DOUBLE HOLE LID	
—	RM-1-LL	—	RM-1-TT	196.0
RM-11 Extra Heavy Top Lid	—	—	RM-11-TT	220.0
RM-12 Double Extra Heavy Top Lid	—	—	RM-12-TT	229.0
WITH PLASTIC INNER LIDS				
—	RM-2-LL	RM-2-T	RM-2-TT	172.9
RM-21 Extra Heavy Top Lid	—	RM-21-T	RM-21-TT	217.7
RM-22 Double Extra Heavy Top Lid	—	RM-22-T	RM-22-TT	226.7

Lids Only for Rectangular Meter Pit Covers

CATALOG NUMBER	DESCRIPTION	APPROX. WT. LBS.
<input type="checkbox"/> RML-1	Standard Weight Top Lid	32.0
<input type="checkbox"/> RMLP-1	Plastic Top Lid	23.0
<input type="checkbox"/> RML-11	Extra Heavy Top Lid	56.0
<input type="checkbox"/> RML-12	Double Extra Heavy Top Lid	65.0

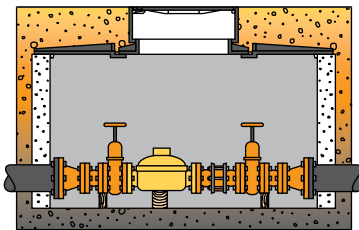

Cut-away side view drawing of a typical 3' x 6' rectangular meter pit setting using extension plates on each side of the frame.

Parts for Rectangular Meter Pit Covers

CATALOG NUMBER	DESCRIPTION	APPROX. WT. LBS.
PR	Ring (with lid recess) for Rectangular Pit Cover 6" Height	50.0
PRR-2	2" Riser Ring for Rectangular Cover Raises Lid Opening 2"	20.0
<input type="checkbox"/> RR-1	Ring Casting with Standard Weight Top Lid	82.0
<input type="checkbox"/> RR-11	Ring Casting with Extra Heavy Top Lid	106.0
<input type="checkbox"/> RR-12	Ring Casting with Double Extra Heavy Top Lid	115.0

NOTE: Locking lids are supplied with a standard pentagon bolt. For an optional large bolt, add "-LB" to the catalog number. For example, a MC-30-LB is a MC-30 cover with a large bolt on the locking lid.

OPTIONAL: Locking electronic meter reading lid is available. Add "-T" for single hole or "-TT" for two 2" holes.

Round Pit Ring and Lid

The round pit ring and lid comprises a flanged ring 26" in diameter with a 20" lid. The depth of the ring is 3". The standard weight lid is not intended to withstand traffic, but extra heavy and double extra heavy lids are optional and will withstand light driveway traffic.



Iron Round Pit Ring and Lid

CATALOG NUMBER				APPROX. WT. LBS.
RING WITH LOCKING LID	RING WITH LOCKLESS LID	RING WITH LOCKING ELECTRONIC METER READING LID (2" HOLE)		
		SINGLE HOLE LID	DOUBLE HOLE LID	
10	10-LL	10-T	10-TT	67.0
11 Extra Heavy Top Lid	-	11-T	11-TT	91.0
12 Double Extra Heavy Top Lid	-	12-T	-	101.0

Round Pit Ring Parts

CATALOG NUMBER	DESCRIPTION	APPROX. WT. LBS.
RPR	Ring for Round Pit Ring	32.0
PRR-2	2" Riser Ring for Round Pit Cover - Raises Lid Opening by 2"	24.0

Round pit rings are available with lockless lids. For lids only, order style RML from "Top Lids Only for Monitor, Pit and Rectangular Covers."

Special Spiked Cover

This cover with inset lid fits an 18" I.D. meter box barrel. It is 4" in depth with a lid opening of 11-1/2". Lids are interchangeable with Type C lids but are inset, not overlapping. Integral cast iron anchor spikes on frame prevent settling when installed in a concrete walk or when using in a driveway with an extra heavy lid for light vehicular traffic.

Special Spiked Iron Cover

CATALOG NUMBER	LID SIZE*	TILE SIZE	APPROX. WT. LBS.
A32C	11-1/2"	18"	34.0



Special Spiked Iron Cover with Extra Heavy Lid

CATALOG NUMBER	LID SIZE*	TILE SIZE	APPROX. WT. LBS.
A32CH	11-1/2" Extra Heavy	18"	42.0

Ford Adjustable Cover

The adjustable cover is ideal for grade changes after the initial meter pit installation. This cover fits an 18" I.D. barrel and will adjust from 1-1/2" to 5" above the top of the barrel. The lid is interchangeable with Type C lids (11-1/2" lid opening) but is inset, not overlapping. Two cut-away drawings at right show extremes of adjustability. In the far right drawing, the flange casting is inverted to place lid in as low a position as possible.



Adjustable Iron Cover

CATALOG NUMBER	LID SIZE*	TILE SIZE	APPROX. WT. LBS.
□ 32B	11-1/2"	18"	46.0

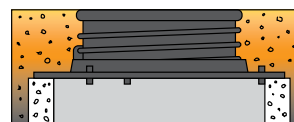

Maximum adjustment of 5 inches



Flange inverted to obtain minimum rise of 1-1/2 inches

* Lid size indicates approximate pit access opening; actual lid diameter is approximately 1" larger.

OPTIONAL: Lockless lid is available: Add "-LL" to the end of catalog number.

□ Locking electronic meter reading lid is available. Add "-T" for single hole or "-TT" for two 2" holes.

Section D

Ford[®] Meter Box Covers

Warranty

All merchandise is warranted to be free from defects in material and factory workmanship for one year from date of shipment from our factory. We will provide, free of charge, new products in equal quantities for any that prove defective within one year from date of shipment from our factory. Manufacturer shall not be liable for any loss, damage, or injury, direct or consequential, arising out of the use of or the inability to use the product. Before using, user shall determine the suitability of the product for user's intended use and user assumes all risk and liability whatever in connection therewith. No claims for labor or consequential damage will be allowed. The foregoing may not be changed except by agreement signed by an officer of the manufacturer.

No other warranties are applicable or may be implied, including the implied warranty of merchantability and the implied warranty of fitness for particular purpose and any warranty relating to infringement or the like, all of which are disclaimed.

Please Note:

Consult the Ford Meter Box Company, Inc. website (www.fordmeterbox.com) for the most recent catalog information. The Ford Meter Box Company considers the information in this catalog to be correct at the time of publication. Items and option availability, including specifications, are subject to change without notice. Please verify that your product information is current.



36 Hudson Rd
Sudbury MA 01776



800-225-4616
www.tisales.com



The Ford Meter Box Company, Inc. 775 Manchester Avenue, P.O. Box 443, Wabash, Indiana, USA 46992
Telephone: 260.563.3171 • FAX: 1.800.826.3487 • Overseas FAX: 260.563.0167 • fordmeterbox.com