

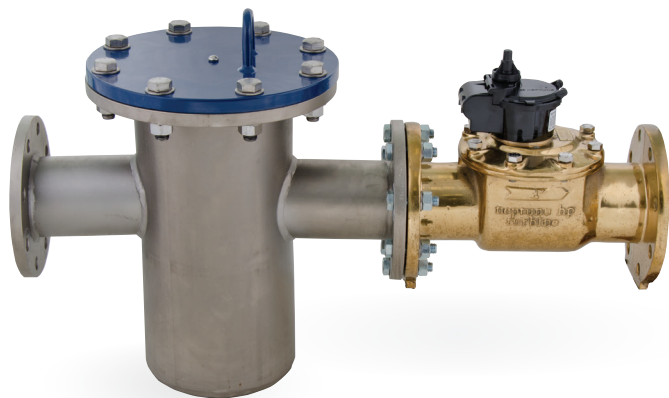

# HIGH PERFORMANCE FIRE SERVICE TURBINE STAINLESS STEEL (S) METER

SIZES: 3", 4", 6", 8", AND 10"



The High Performance (HP) Fire Service Turbine Stainless Steel (S) meter offers some of the widest flow ranges of any fire service turbine meters on the market. All HP Fire Service Turbines meet or exceed the latest AWWA Standard C703. Maximum continuous flow rates may be exceeded by as much as 25% for intermittent periods.

APPLICATION

The HP Fire Service Turbine S meter is designed to measure both domestic and fire service usage where flow rates are moderate to high. All HP Fire Service Turbine meters are NSF/ANSI 61, Annex G and F certified, Underwriters Laboratory (UL) listed, and Factory Mutual (FM) approved for fire service use and include an attached fire service strainer.

CONSTRUCTION

The HP Fire Service Turbine S meter consists of a stainless steel fire service strainer, a rugged lead free high copper alloy maincase, an AWWA Class II turbine measuring element, and a roll-sealed register.

The Unitized Measuring Element (UME) allows for quick, easy, in-line interchangeability. Water volume is measured accurately at all flows by a specially designed assembly. The hydrodynamically balanced thrust compensated rotor relieves pressure on the thrust bearing. Stationary stainless steel shafts minimize wear and provide sustained accuracy over an extended operating life. Direct coupling of the rotor to the gear train eliminates revenue loss due to slippage during fast starts and line surges. A calibration vane allows in-field calibration of the UME to lengthen service life and to ensure accurate registration.

The roll-sealed register eliminates leaking and fogging. A magnetic drive couples the register with the measuring element. For reading convenience, the register can be mounted in any one of four positions on the meter.

KEY FEATURES

- Turbine Measuring Element
  - UL listed
  - FM approved
  - Wide flow ranges available at 98.5% - 101.5% accuracy
  - Interchangeable measuring element
  - Calibration vane
  - Hydrodynamically balanced rotor
  - Reusable O-ring gasket provides superior seal
- Lead Free Maincase
  - NSF/ANSI 61, Annex G and Annex F certified
  - Made from lead free high copper alloy
  - Proven lifetime material
  - Corrosion resistant
- Stainless Steel Strainer
  - Stops debris while permitting full flow
  - Lightweight and easy to handle
- Roll-Sealed Registers
  - Magnetic driven, low torque registration
  - Low flow indicator
  - In-line serviceability
  - Tamperproof seal design

WARRANTY

Neptune provides a limited warranty with respect to its HP Fire Service Turbine S meters for performance, materials, and workmanship.

When desired, owner maintenance is easily accomplished by in-line replacement of the UME.

SYSTEMS COMPATIBILITY

Adaptability to all present and future systems for flexibility.

### 3" HP TURBINE ACCURACY

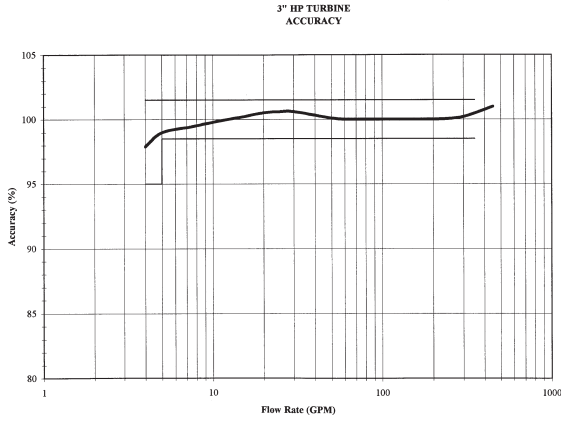

### 3" FIRE SERVICE TURBINE S

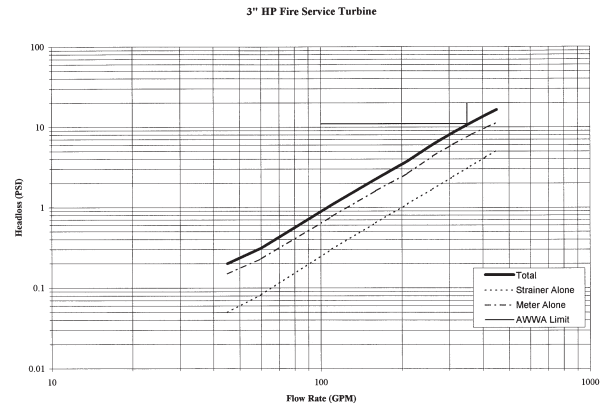

### 4" HP TURBINE ACCURACY

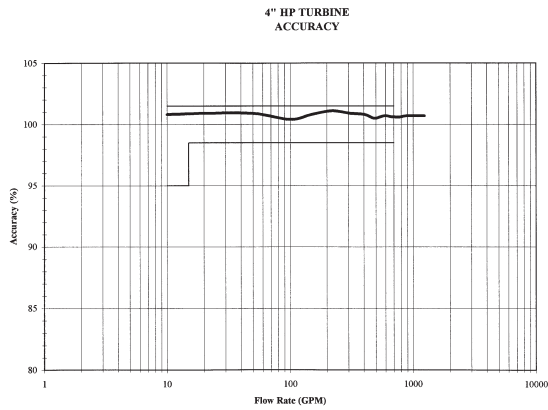

### 4" FIRE SERVICE TURBINE S

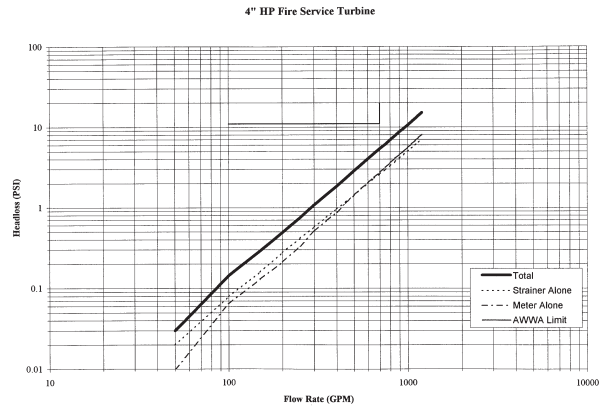

### 6" HP TURBINE ACCURACY

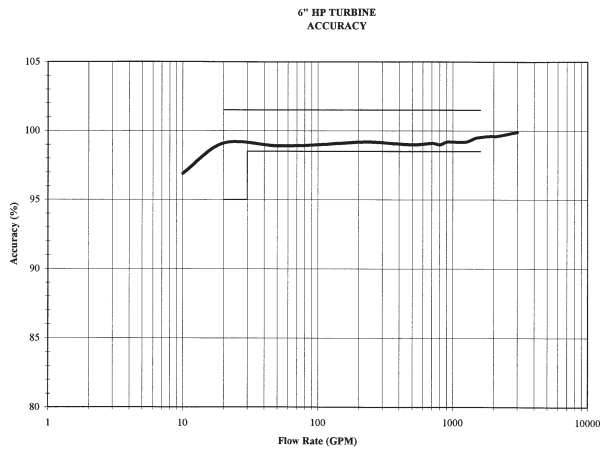

### 6" FIRE SERVICE TURBINE S

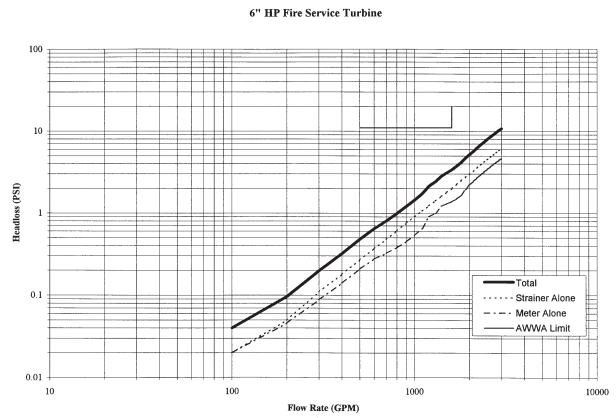

## 8" HP TURBINE ACCURACY

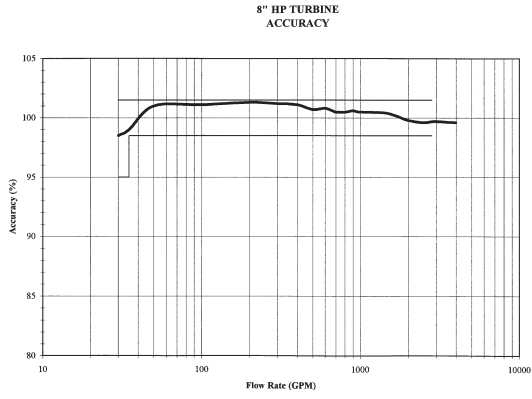

## 8" FIRE SERVICE TURBINE S

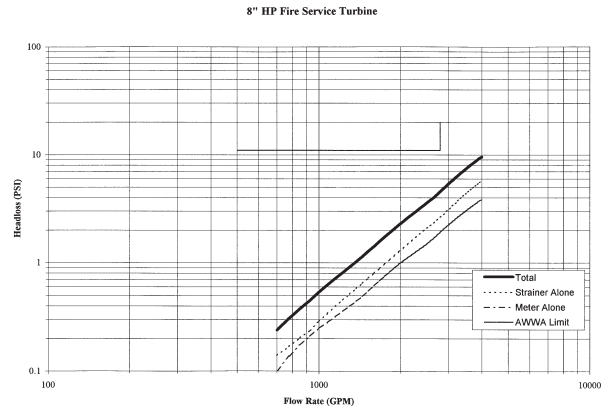

## 10" HP TURBINE ACCURACY

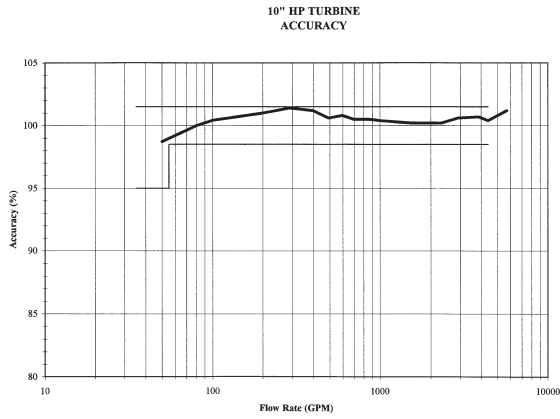

## 10" FIRE SERVICE TURBINE S

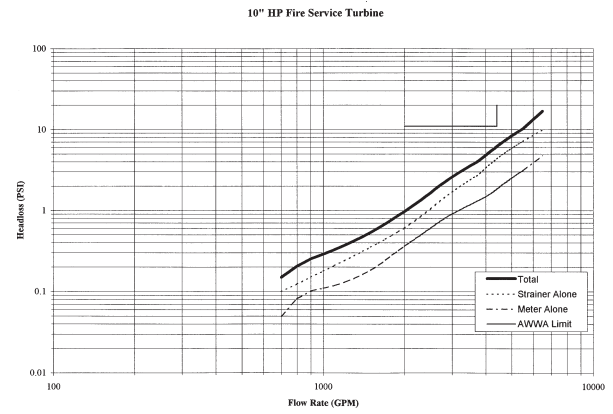

*These charts show typical meter performance. Individual results may vary.*

### GUARANTEED SYSTEMS COMPATIBILITY

All HP Fire Service Turbine S meters are guaranteed adaptable to our ARB® V, ProRead™ (ARB VI), E-Coder®)R900i™, E-Coder®, TRICON®/S, TRICON/E®3, and Neptune meter reading systems without removing the meter from service.

### REGISTRATION

Registration (per sweep hand revolution)		3" & 4"	6"	8" & 10"
1,000	Gallons		✓	✓
100	Gallons	✓		
100	Cubic Feet		✓	✓
10	Cubic Feet	✓		
10	Cubic Metres		✓	✓
1	Cubic Metre	✓		

Register Capacity ( 6-wheel odometer)		3" & 4"	6"	8" & 10"
1,000,000,000	Gallons		✓	✓
100,000,000	Gallons	✓		
100,000,000	Cubic Feet		✓	✓
10,000,000	Cubic Feet	✓		
10,000,000	Cubic Metres		✓	✓
1,000,000	Cubic Metres	✓		

### OPERATING CHARACTERISTICS

Meter Size	Normal Operating Range @ 100% Accuracy (+/- 1.5%)	Maximum Intermittent Flow	AWWA Standard
3"	5 to 450 US gpm 1.14 to 102.2 m³/h	560 US gpm 127.2 m³/h	8 to 350 US gpm 1.8 to 79.5 m³/h
4"	10 to 1200 US gpm 2.27 to 272.5 m³/h	1500 US gpm 340.7 m³/h	15 to 630 US gpm 3.4 to 143.0 m³/h
6"	20 to 2500 US gpm 4.55 to 567.8 m³/h	3100 US gpm 704.1 m³/h	30 to 1400 US gpm 6.8 to 317.9 m³/h
8"	35 to 4000 US gpm 7.95 to 908.5 m³/h	5000 US gpm 1135.6 m³/h	50 to 2400 US gpm 11.4 to 545 m³/h
10"	50 to 6500 US gpm 11.36 to 1476.3 m³/h	8000 US gpm 1817 m³/h	75 to 3800 US gpm 17.0 to 863 m³/h

### DIMENSIONS

Meter Size	A in/mm	B in/mm	C in/mm	D in/mm	E in/mm	F in/mm	G in/mm	Width in/mm	Weight lbs/kg
3"	14 1/8 359	12 305	10 3/4 273	10 5/8 270	17 1/2 445	26 1/8 664	2 51	13 1/2 343	150 68
4"	21 533	14 356	10 3/4 273	10 5/8 270	17 1/2 445	35 889	2 51	13 1/2 343	200 91
6"	26 7/8 683	18 457	11 3/8 289	11 1/16 281	21 1/4 540	44 7/8 1140	3 76	19 483	425 139
8"	31 5/16 795	20 508	13 29/64 342	11 13/16 300	25 1/8 657	51 5/16 1303	3 76	25 635	600 272
10"	30 782	26 660	15 381	14 13/16 376	30 1/16 764	56 1422	3 76	27 1/2 699	750 340

### SPECIFICATIONS

- Application: cold water measurement of flow in one direction
- Maximum operating water pressure: 175 psi (1206 kPa)
- Registers: direct reading, center-sweep, roll-sealed magnetic drive with low flow indicator
- Measuring element: AWWA Class II turbine, hydrodynamically balanced rotor
- Strainer: Stainless steel body, stainless steel basket strainer element, NSF/ANSI 61 certified, UL listed, and FM approved
- 300 series stainless steel bolts

### OPTIONS

- Sizes: 3", 4", 6", 8", and 10"
- 300 series stainless steel strainer cover
- Units of measure: U.S. gallons, imperial gallons, cubic feet, cubic metres
- Register types:
  - Direct
  - Remote reading system\*: ProRead, E-Coder)R900i, E-Coder, TRICON/S, TRICON/E3
  - Reclaim
- Companion flanges:
  - Cast iron
  - Bronze (3" and 4" only)

\*Consult factory for meter performance specifications when fitted with ARB.

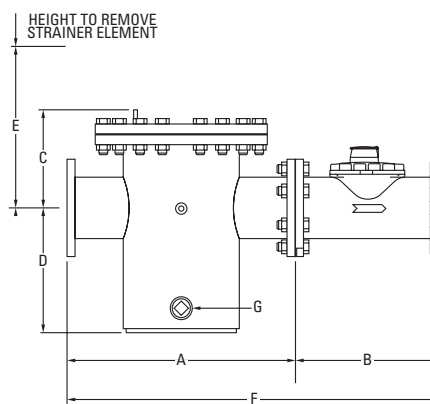

Neptune Technology Group Inc.  
1600 Alabama Highway 229  
Tallahassee, AL 36078  
USA  
Tel: (800) 633-8754  
Fax: (334) 283-7293



36 Hudson Rd  
Sudbury MA 01776



800-225-4616  
www.tisales.com